

# EMBEDDED POWER

AC-DC AND DC-DC POWER CONVERSION SOLUTIONS



PRECISION | POWER | PERFORMANCE

## Table of Contents

### AC–DC Power Supplies

#### Low Power Up to 650 W

- 10 Open frame/enclosed 1 to 4 outputs
- 28 External power adapters

#### Fanless/Conduction Cooled Up to 1000 W

- 18 LCC250 Series
- 20 LCC600 Series
- 22 CoolX®600 Series
- 24 CoolX®1000 Series
- 26 CS1000 Series

#### Healthcare Power Up to 24000 W

- 29 1 to 24 outputs

#### Modular Up to 24000 W

- 34 UltiMod Series
- 36 Intelligent Medium Power (iMP)
- 40 Micro Medium Power (μMP)
- 42 CoolX®1800
- 44 CoolX®3000
- 46 Intelligent Medium-High Power
- 50 Precision High Power System (iHP)
- 54 Intelligent Transfer Switch (iTS)

#### Bulk Power Up to 12000 W

- 56 LCM Series
- 66 Xsolo Series
- 68 Distributed power bulk front end

#### Distributed and CRPS Power Up to 3000 W

- 72 DS Series
- 79 CSU Series
- 81 CSV Series

#### Racks

- 82 PS1000 and PL1000
- 84 PS1650
- 86 50 V, 18 kW, 1U Open Rack Power Shelf
- 87 50 V, 36 kW, 2U Open Rack Power Shelf
- 88 50 V, 3 kW, Open Rack Rectifier
- 89 48 V, 36 kW, 2U Open Rack Power Shelf
- 90 48 V, 3 kW, Open Rack Rectifier with ATS

#### DIN Rail (ADN) Up to 960 W

- 91 Single & 3-phase

### DC–DC Converters

#### Industry Standard Isolated

- 95 Quarter-Brick
- 96 Eighth-Brick
- 98 Sixteenth-Brick
- 100 RF Power Brick
- 101 Wide Input Voltage
- 101 Direct Conversion – PSA Series

#### Industry Standard Non-isolated

- 102 C-Class
- 104 POLA Products
- 105 Digital DC-DC Converters

#### High Power 300 V Input

- 106 On-board AC–DC Distributed Architecture
- 107 Power Factor Correction (PFC)

#### Low Power Isolated

- 108 Low Power Isolated DC-DC
- 115 DC-DC Converter for Railway Application
- 117 DC-DC Converter for Medical Application

#### High Voltage DC-DC Modules

- 119 Mission-Critical High Voltage Solutions

## Advanced Energy shapes and transforms how power is used, delivered, and managed.

Advanced Energy has devoted more than three decades to perfecting power for its global customers. We design and manufacture highly engineered, precision power conversion, measurement, and control solutions for mission-critical applications and processes.

Advanced Energy offers a broad portfolio of AC-DC and DC-DC power supplies from its Artesyn, Excelsys, and UltraVolt product lines which enables customer innovation in complex applications for a wide range of industries including semiconductor equipment, industrial, manufacturing, telecommunications, data center computing, and medical. With deep application know-how and responsive service and support across the globe, we build collaborative partnerships to meet rapid technological developments, propel growth for our customers, and innovate the future of power.

---

### Local Support

Our regional sales offices are ready to provide expert local applications and sales support. In addition, an extensive network of manufacturers' representatives and distributors bring our products to you. Please call for sales office locations near you or visit our website at [advancedenergy.com](http://advancedenergy.com).

#### Contact Us

Americas (USA)  
Telephone: +1 888 412 7832

Europe (UK)  
Telephone: +44 (0) 1384 842 211

Asia (HK)  
Telephone: +852 2176 3333

#### Technical Support

Americas (USA)  
+1 888 412 7832 (North America)

Europe, Middle East & Africa (EMEA)  
0 800 0321546 (UK)  
+44 800 0321546 (outside UK)

Asia  
+400 88 99 130 (China)  
+86 29 8874 1895 (outside China)

Sales Support: [powersales@aei.com](mailto:powersales@aei.com)

Product Support: [productsupport.ep@aei.com](mailto:productsupport.ep@aei.com)

# Embedded Power Selector Guide

AC-DC

## MODULAR

### UltiMod

Up to 1200 W  
1 to 12 Outputs



### iMP Series

Up to 1500 W  
1 to 21 Outputs



### uMP Series

Up to 1800 W  
Up to 12 Outputs



### CoolX1800, CoolX3000

Up to 3000 W  
Up to 12 Outputs



### iVS Series

Up to 4920 W  
1 to 24 Outputs



### iHP Series, iTS Series

Up to 24000 W  
Up to 8 Outputs



## BULK/DISTRIBUTED/ENCLOSED

### LCM Series

300, 600, 1000,  
1500, 3000 W  
85 to 264 VAC  
12 to 72  
VDC



### Xsolo Series

500, 1000 W  
85 to 264 VAC  
120 to 380 VDC



### DS Series

450 to 3000 W  
90 to 264 VAC  
12, 24, 48 VDC



### CSU Series

550, 800, 1300,  
1800, 2000, 2400 W  
90 to 264 VAC  
12 VDC



### CSV Series

1100, 1300, 1600,  
2000 W  
90 to 264 VAC  
12 VDC



### UFE Series

1300 to 2000 W  
85 to 264 VAC  
24, 48 VDC



### HPS Series

1 to 3000 W  
90 to 264 VAC  
48 VDC



## RACKS

### Open Rack Power Shelf and Rectifier

1U,  
18 kW



### Open Rack Power Shelf and Rectifier

2U  
36 kW



### Open Rack Power Shelf and Rectifier with ATS

2U  
36 kW



### DSR1

1U, 6 kW  
Accepts 5 DS units



### UFR

1U, 6 kW  
Accepts 3 UFE units



### HPR1

1U, 12 kW  
Accepts 4 HPS3000



## OPEN FRAME

### 2x4

NPS20-M  
25 to 40 W  
NPS40-M  
45 to 60 W  
NPT40-M  
45 to 55 W  
NPS60-M  
60 W  
LPT100-M  
130 W  
LPS100-M  
100 to 150 W  
CPS250-M  
150 to 250 W



### 3x5

LPS40/40-M  
40 to 55 W  
LPT60  
60 to 80 W  
LPS60/60-M  
60 to 80 W  
TLP150  
100 to 150 W  
LPQ200-M  
100 to 200 W  
LPS200-M  
125 to 250 W  
LPS360-M  
240 to 360 W



### 4x6

CNS650-MU  
400 to 650 W



### 4x7

NLP250  
175 to 250 W



## ADAPTERS

### AD, DA, DP Series

10 to 100 W



## SPECIAL

### ADN-C Series

120 to 960 W  
Single & 3-phase  
Approved for UL508  
& Hazardous  
Locations



## FANLESS/ CONDUCTION COOLED

**LCC250**  
250 W



**LCC600**  
600 W



**CoolX600**  
600 W



**CoolX1000**  
1000 W



**CS1000**  
1000 W



## DC-DC

### LOW VOLTAGE

#### PFC

Full Brick; *AIF*  
3/4 Brick; *AIT*  
1/4 Brick; *AIQ*

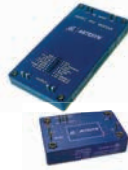

#### High Power

Full Brick; *AIF*  
3/4 Brick; *AIT*  
1/2 Brick; *AIH*  
1/4 Brick; *BDQ/BCQ*



#### Telecom DC-DC

1/16th brick 35 to 120 W; *ALD/AVD*  
1/8th brick 50 to 300 W; *AVO/ADO*  
1/4 brick 50 to 800 W; *AVQ/ADQ*  
1/2 brick 300 to 700 W; *AVE/ADH*  
Full brick 500 to 800 W; *AGF*

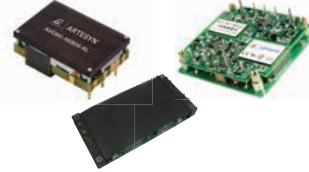

#### Industrial DC-DC

0.5 by 0.5 DIP 3 W; *AYA*  
0.9 by 0.5 DIP 3 W; *ATA*  
1.2 by 0.8 DIP 24 6 W, 10 W; *ASA*  
1 by 1; 10 W, 20 W, 25 W; *AXA*  
1 by 2; 15 W, 40 W, 50 W; *AEE*  
1.6 by 2; 25 W, 30 W; *AET*



#### Direct Conversion - PSA Series

100 A; *ADC*



#### Non-isolated DC-DC

C2 Class 3 to 60 A; *LDO, SMT, SIL*  
LGA package 3 to 20 A; *LGA*  
LGA50D, LGA80D 25 to 80 A;  
*LGA50D, LGA80D*  
POLA package 6 to 60 A; *PTH*



#### Medical DC-DC

0.8 by 1.2;  
Medical 6 W; *ASA*  
1 by 2;  
Medical 10 W, 15 W,  
20 W; *AEE*

#### Railway DC-DC

1 by 2; Railway  
10 W, 20 W; *ERM*  
1/4 brick Railway  
50 W, 75 W; *ERM*



### HIGH VOLTAGE

#### C

Output voltage  
125 V to 60 kV  
Output power  
60, 125, or 250 W



#### A

Output voltage  
62 V to 40 kV  
Output power  
4, 15, 20, and 30 W



#### LE

Output voltage  
1 to 30 kV  
Output power  
4, 20, and 30 W



#### AA

Output voltage  
62 V to 6 kV  
Output power  
4, 20, and 30 W



#### HVA

Output voltage  
1 to 20 kV  
Max output power  
2 W



#### HVA

Output voltage  
1 to 20 kV  
Max output power  
2 W



## **A History of Innovation**

At Advanced Energy, our engineers have been designing and developing power supply products for more than 40 years. Our products have helped pave the way for advancements in numerous applications in the communications, industrial, computing, data storage, and healthcare markets.

When developing products, time is money. Every step in the process that you can eliminate, speed up, or make more effective accelerates your time-to-market and lowers your R&D costs.

Major advantages of partnering with us include:

- Broadest power supply product lines
- Highly versatile power supplies
- Modified standards and value-add services
- Low energy consumption
- Eco-friendly products
- Space-efficient power
- Reliability and quality
- Worldwide distributor network
- Vast knowledge, experience and expertise



**Accelerate, Improve, and Enhance the Capabilities of  
Your Next System Design.**

Advanced Energy utilizes the following design methodologies and techniques to ensure that our power supplies meet the rigorous quality and reliability requirements of the communications, industrial, computing, data storage, and healthcare markets.

---

## Power for the Next Generation

Many of our products incorporate powerful programming, monitoring, and self-testing software providing system engineers with critical data to manage power consumption. High efficiency, green design and manufacturing technologies, and innovative demand and supply replenishment systems collectively deliver key business efficiencies and new design capabilities.

Advanced Energy can help take your new product design or redevelopment efforts to the next level with a shorter time-to-profit, higher reliability, and greater scalability.

- **Shorter Time-to-Market** – our latest programmable power solutions and our modular, medium/high power  $\mu$ MP and iMP series provide you with shorter time-to-market and offer faster test and qualification than traditional analog power solutions. Our modified standards and value-add services also provide turn-key solutions for the best application match to help accelerate time-to-market without compromising quality.
- **Higher Reliability** – moving from inflexible fixed-output analog power supplies to programmable power solutions enables our engineers to more extensively test and document our products to ensure they meet or exceed your reliability requirements. We also provide a wide range of environmental, EMC compliance, and safety certifications to help speed your product design process.
- **Greater Scalability** – many of our latest power solutions are scalable, programmable, and plug-compatible with our earlier-generation products, enabling you to quickly address changes or enhancements to your systems. You can now satisfy most changes in power requirements by reprogramming the power supply and, if your needs change radically, you can easily swap to a more capable solution. This inherent scalability eliminates redesign costs, reduces testing time, and provides you with greater design flexibility.

## Power Supply Design Controls

### Reliability Models and Predictions

- A prediction of design reliability in terms of Mean Time Between Failures (MTBF) using Telecordia, Bellcore, or MIL-HDBK-217F
- Not intended as a measure of expected field performance, but for design trade-off analysis and review of part stress derating performance

### Failure Modes and Effect Analysis

- An analytical technique to identify and review failure modes, their causes, mechanisms, and effects
- Provides a formal risk assessment to reduce field failures at the customer site

### Component Selection

- Database warehouse of all component information
- Design engineers can only select components rigorously approved from suppliers that have undergone strict qualification and auditing process

### Derating Analysis

- Intended to reduce the failure rate of components

### Design for Manufacturability

- Design rules regarding manufacturability

### Simulation Analysis – Computer-aided Engineering Tools

- Thermal Simulation
- Circuit Simulation
- EMI Field Simulation
- Detailed Mechanical Design
- PCB Layout and Tracking
- Structural Simulation

For additional information, visit [advancedenergy.com](http://advancedenergy.com)

## Advanced Energy Computer-aided Engineering Tools

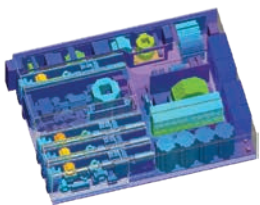

Thermal Simulation

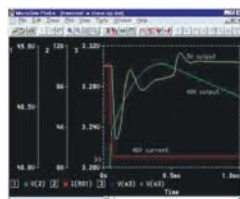

Circuit Simulation

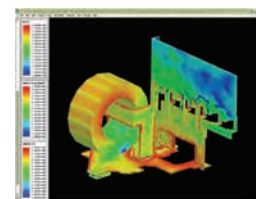

EMI Field Simulation



Detailed Mechanical Design

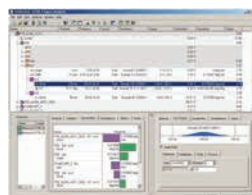

PCB Layout and Tracking



Structural Simulation





# AC-DC Power Supplies

Advanced Energy is widely acknowledged as an industry leader and produces an exceptionally wide range of AC-DC power conversion products.

## LOW POWER

# Low Power

## Open Frame 1 to 4 Outputs

20 to 650 Watts



### SPECIAL FEATURES

#### All models feature

- Industry standard footprints
- Wide-range AC input
- Full power to 50°C
- High demonstrated MTBF
- Over-voltage protection
- Over-load protection
- Built-in EMI filtering
- Extensive safety approvals
- Derated operation to 70°C

#### Many models feature

- EN61000-3-2 compliance
- Supervisory outputs (5 V/12 V)
- Wide-adjust floating 4<sup>th</sup> output
- Single wire current share
- Medical approvals
- Remote sense
- Adjustable outputs
- Power fail
- Wide-adjust on single output models
- Derated operation to 80°C





Low Power										
Output Power		Output				Size W x L x H (mm)	Model			
[Forced Air]	Free Air	V1	V2	V3	V4					
[40 W]	25 W	<b>NPS20-M Series<sup>3</sup></b>				2" x 4" x 1" (50.8 x 101.6 x 25.4)	NPS22-M NPS23-M NPS24-M NPS25-M NPS28-M			
		5 V @ 5 A [8 A] <sup>2</sup>								
		12 V @ 2.1 A [3.3 A] <sup>2</sup>								
		15 V @ 1.7 A [2.7 A] <sup>2</sup>								
		24 V @ 1 A [1.8 A] <sup>2</sup>								
		48 V @ 0.5 A [0.84 A] <sup>2</sup>								
[55 W]	40 W	<b>LP40 Series<sup>3</sup></b>				3" x 5" x 1.2" (76.2 x 127 x 30.5)	LPS41 LPS42 LPS43 LPS44 LPS45 LPS48 LPT41 LPT42 LPT43 LPT44 LPT45 LPT46 LPT47			
		3.3 V @ 8 A [11 A] <sup>2</sup>								
		5 V @ 8 A [11 A] <sup>2</sup>								
		12 V @ 3.3 A [4.5 A] <sup>2</sup>								
		15 V @ 2.6 A [3.6 A] <sup>2</sup>								
		24 V @ 1.6 A [2.3 A] <sup>2</sup>								
		48 V @ 0.9 A [1.2 A] <sup>2</sup>								
		3.3 V @ 4 A [7 A]	5 V @ 1.5 A [2 A]	+12 V @ 0.5 A [0.7 A]						
		5 V @ 4 A [5 A]	12 V @ 2 A [2.5 A]	-12 V @ 0.5 A [0.7 A]						
		5 V @ 6 A [8 A]	12 V @ 0.5 A [0.7 A]	-12 V @ 0.5 A [0.7 A]						
		5 V @ 4 A [5 A]	12 V @ 2 A [2.5 A]	-5 V @ 0.5 A [0.7 A]						
		5 V @ 4 A [5 A]	15 V @ 2 A [2.5 A]	-15 V @ 0.5 A [0.7 A]						
		5 V @ 4 A [5 A]	24 V @ 1 A [1.5 A]	+12 V @ 0.5 A [0.7 A]						
		5 V @ 4 A [5 A]	24 V @ 1 A [1.5 A]	-12 V @ 0.5 A [0.7 A]						
	[55 W]	45 W	<b>NPT40-M Series<sup>3</sup></b>					2" x 4" x 1" (50.8 x 101.6 x 25.4)	NPT42-M NPT43-M NPT44-M	
			5 V @ 5 A [8 A]	12 V @ 2.5 A [3 A]	-12 V @ 0.5 A [0.7 A]					
			5 V @ 5 A [8 A]	15 V @ 2 A [2.4 A]	-15 V @ 0.5 A [0.7 A]					
		5 V @ 5 A [8 A]	24 V @ 1 A [1.5 A]	12 V @ 0.5 A [0.7 A]						

[ ] Rating with 30 CFM of air

1 Optional cover/enclosure

2 Floating output

3 This product is a component power supply and is only for inclusion by professional installers within other equipment and must Not be operated as a standalone product. EMC compliance to appropriate standards must be verified at the system level. This product is for sale to OEMs and system integrators, including through distribution channels. It is Not intended for sale to end users.

Low Power							
Output Power		Output				Size W x L x H (mm)	Model
[Forced Air]	Free Air	V1	V2	V3	V4		
[60 W]	45 W	<b>NPS40-M Series<sup>3</sup></b>				2" x 4" x 1" (50.8 x 101.6 x 25.4)	NPS42-M
1 	5 V @ 8 A [11 A] <sup>2</sup>						NPS43-M
	12 V @ 3.75 A [5 A] <sup>2</sup>						NPS44-M
	15 V @ 3 A [4 A] <sup>2</sup>						NPS45-M
	24 V @ 1.9 A [2.5 A] <sup>2</sup>						NPS48-M
	48 V @ 0.94 A [1.25 A] <sup>2</sup>						
[60 W]	60 W	<b>NPS60-M Series<sup>3</sup></b>				2" x 4" x 1"	NPS62-M
1 	5 V @ 11 A <sup>2</sup>						NPS63-M-006
	12 V @ 5 A <sup>2</sup> (Level VI Efficiency)						NPS64-M
	15 V @ 4 A <sup>2</sup>						NPS65-M
	24 V @ 2.5 A <sup>2</sup>						
[80 W]	60 W	<b>LP60 Series<sup>3</sup></b>				3" x 5" x 1.65" (76.2 x 127 x 41.9)	LPS61
1 	3.3 V @ 12 A [16 A] <sup>2</sup>						LPS62
	5 V @ 12 A [16 A] <sup>2</sup>						LPS63
	12 V @ 5 A [6.7 A] <sup>2</sup>						LPS64
	15 V @ 4 A [5.3 A] <sup>2</sup>						LPS65
	24 V @ 2.5 A [3.3 A] <sup>2</sup>						LPS68
	48 V @ 1.3 A [1.7 A] <sup>2</sup>						LPT61
	3.3 V @ 5 A [8.5 A]	5 V @ 2.5 A [3 A]	+12 V @ 0.5 A [1 A]				LPT62
	5 V @ 7 A [8 A]	12 V @ 3 A [3.5 A]	-12 V @ 0.7 A [1 A]				LPT63
	5 V @ 7 A [8 A]	15 V @ 2.8 A [3.3 A]	-15 V @ 0.7 A [1 A]				LPT64
	5 V @ 7 A [8 A]	12 V @ 3 A [3.5 A]	-5 V @ 0.7 A [1 A]				LPT65
	5 V @ 7 A [8 A]	24 V @ 1.5 A [2 A]	+12 V @ 0.7 A [1 A]				
	[130 W]		<b>LPT100-M Series<sup>3</sup></b>				2" x 4" x 1.28" (50.8 x 101.6 x 32.7)
1 	3.3 V @ [18 A]	5 V @ [9 A]	12 V @ [2.3 A]			LPT102-M	
	5 V @ [18 A]	12 V @ [9 A]	-12 V @ [2 A]			LPT103-M	
	5 V @ [18 A]	15 V @ [7.2 A]	-15 V @ [1.5 A]			LPT104-M	
	5 V @ [18 A]	24 V @ [3 A]	12 V @ [2.3 A]				





[ ] Rating with 30 CFM of air

1 Optional cover/enclosure

2 Floating output

3 This product is a component power supply and is only for inclusion by professional installers within other equipment and must Not be operated as a standalone product. EMC compliance to appropriate standards must be verified at the system level. This product is for sale to OEMs and system integrators, including through distribution channels. It is Not intended for sale to end users.

## LOW POWER





Low Power								
Output Power		Output				Size W x L x H (mm)	Model	
[Forced Air]	Free Air	V1	V2	V3	V4			
[150 W]	100 W	TLP150 Series <sup>3</sup>						
1 		12 V @ 12.5 A <sup>2</sup>				3" x 5" x 1.25" (76.2 x 127 x 31.75)	TLP150R-96S12J	
		24 V @ 6.3 A <sup>2</sup>					TLP150R-96S24J	
		36 V @ 4.2 A <sup>2</sup>					TLP150R-96S36J	
		48 V @ 3.2 A <sup>2</sup>					TLP150R-96S48J	
[150 W]	100 W	LPS100-M Series <sup>3</sup>						
1 		5 V @ 16 A [24 A] <sup>2</sup>				2" x 4" x 1.29" (50.8 x 101.6 x 33)	LPS102-M	
		12 V @ 8.3 A [12.5 A] <sup>2</sup>					LPS103-M	
		15 V @ 6.7 A [10 A] <sup>2</sup>					LPS104-M	
		24 V @ 4.2 A [6.3 A] <sup>2</sup>					LPS105-M	
		48 V @ 2.1 A [3.1 A] <sup>2</sup>					LPS108-M	
		54 V @ 1.85 A [2.8 A] <sup>2</sup>					LPS109-M	
[175 W]	110 W	LP170 Series <sup>3</sup>						
1 		5 V @ 22 A [35 A] <sup>2</sup> (2.5 to 6 V)				4.25" x 8.5" x 1.5" (108 x 215.9 x 38.1)	LPS172	
		12 V @ 9.1 A [15 A] <sup>2</sup> (6 to 12 V)					LPS173	
		15 V @ 7.3 A [12 A] <sup>2</sup> (12 to 24 V)					LPS174	
		24 V @ 4.5 A [7.5 A] <sup>2</sup> (24 to 54 V)					LPS175	
		5 V @ 15 A [30 A] (3.3 to 5.5 V)	12 V @ 6 A [8 A]	-12 V @ 0.2 A [3 A] (-12 to 15 V)	±3.3 to 25 V @ 2 A [5 A] <sup>2</sup>			LPQ172
		5 V @ 10 A [24 A] (3.3 to 5.5 V)	12 V @ 6 A [8 A]	-12 V @ 1.2 A [3 A] (-12 to 15 V)	5 V @ 10 A [24 A] <sup>2</sup> (3.3 to 5 V)			LPQ173
[200 W]	100 W	LPQ200-M Series <sup>3</sup>						
1 		3.3 V @ 13 A [18 A]	5 V @ 13 A [18 A]	12 V @ 5 A [9 A]	-12 V @ 1 A [2 A]	3" x 5" x 1.32" (76.2 x 127 x 33.6)	LPQ201-M	
		5 V @ 13 A [18 A]	12 V @ 5 A [9 A]	24 V @ 1.5 A [3 A]	-12 V @ 1 A [2 A]		LPQ202-M	
[250 W]	125 W	LPS200-M Series <sup>3</sup>						
1 		5 V @ 20 A [40 A] <sup>2</sup>				3" x 5" x 1.32" (76.2 x 127 x 33.6)	LPS202-M	
		12 V @ 10.3 A [20.8 A] <sup>2</sup>					LPS203-M	
		15 V @ 8.3 A [16.6 A] <sup>2</sup>					LPS204-M	
		24 V @ 5.2 A [10.4 A] <sup>2</sup>					LPS205-M	
		48 V @ 2.6 A [5.2 A] <sup>2</sup>					LPS208-M	

[ ] Rating with 30 CFM of air

1 Optional cover/enclosure

2 Floating output

3 This product is a component power supply and is only for inclusion by professional installers within other equipment and must Not be operated as a standalone product. EMC compliance to appropriate standards must be verified at the system level. This product is for sale to OEMs and system integrators, including through distribution channels. It is Not intended for sale to end users.

Low Power							
Output Power		Output				Size W x L x H (mm)	Model
[Forced Air]	Free Air	V1	V2	V3	V4		
[250 W]	155 W	CPS250-M Series <sup>3</sup>					
		12 V @ 12.92 A [20.83 A]				2" x 4" x 1.3" (50.8 x 101.6 x 32.8)	CPS253-M
		24 V @ 6.45 A [10.42 A]					CPS255-M
		48 V @ 3.23 A [5.21 A]					CPS258-M
[250 W]	175 W	NLP250 Series <sup>3</sup>					
1 		12 V @ 21 A <sup>2</sup>				4" x 7" x 1.5" (101.6 x 177.8 x 38.1)	NLP250R-96S12J
		24 V @ 10.5 A <sup>2</sup>					NLP250R-96S24J
		48 V @ 5.3 A <sup>2</sup>					NLP250R-96S48J
		NLP250 – DC (-48 VDC Input) <sup>3</sup>					
		12 V @ 14.6 A [21 A]				4" x 7" x 1.5" (101.6 x 177.8 x 38.1)	NLP250N-48S12J
[350 W]		LPS350 Series <sup>3</sup>					
		5 V (3 to 6 V) @ [70 A] <sup>2</sup>				5" x 9" x 2.5" (127 x 228.6 x 63.5)	LPS352-C
		12 V (6 to 12 V) @ [29.2 A] <sup>2</sup>					LPS353-C
		15 V (12 to 24 V) @ [23.3 A] <sup>2</sup>					LPS354-C
		24 V (24 to 48 V) @ [14.6 A] <sup>2</sup>					LPS355-C
[360 W]	240 W	LPS360-M Series <sup>3</sup>					
		12 V @ 20 A [30 A] <sup>2</sup>				3" x 5" x 1.3" (76.2 x 127 x 33)	LPS363-M
		15 V @ 16 A [24 A] <sup>2</sup>					LPS364-M
		24 V @ 10 A [15 A] <sup>2</sup>					LPS365-M
		36 V @ 6.25 A [11.25 A] <sup>2</sup>					LPS366-M
		48 V @ 5 A [7.5 A] <sup>2</sup>					LPS368-M
[650 W]	400 W	CNS650 Series <sup>3</sup>					
		12 V @ 54.2 A				4" x 7" x 1.6" (101.6 x 177.8 x 40.6)	CNS653-ME
		12 V @ 54.2 A [30.8 A]				3.8" x 6" x 1.3" (101.6 x 152.4 x 34.1)	CNS653-MF
		12 V @ 54.2 A [33.3 A]				4" x 6" x 1.5" (101.6 x 152.4 x 39)	CNS653-MU
		24 V @ 27.1 A [16.7 A]					CNS655-MU
		48 V @ 13.5 A [8.3 A]				CNS658-MU	

[ ] Rating with 30 CFM of air

1 Optional cover/enclosure

2 Floating output

3 This product is a component power supply and is only for inclusion by professional installers within other equipment and must Not be operated as a standalone product. EMC compliance to appropriate standards must be verified at the system level. This product is for sale to OEMs and system integrators, including through distribution channels. It is Not intended for sale to end users.

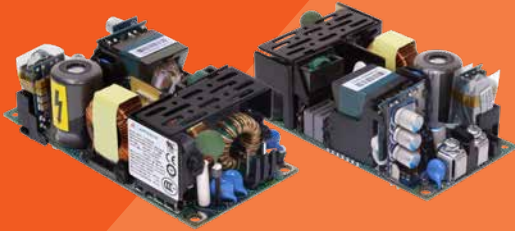

## CPS250-M AT A GLANCE

### Total Power

250 W

### # of Outputs

Single

### Output

- 12 to 48 V
- 12 V Fan Output

### Safety

- TUV 62368-1 / 60601-1
- UL/CSA 62368-1 / 60601-1
- CB IEC 62368-1 / IEC 60601-1
- CE EN60601-1-2 / LVD / RoHS
- CCC

# CPS250-M

## Open Frame

## 250 Watts AC-DC Power Supply

### SPECIAL FEATURES

- Up to 250 W forced air, 155 W natural convection
- 2" x 4" x 1.29" open frame package
- Class I and II operation
- < 500 mW No-load power consumption
- +10% output adjustment
- 12 V fan output
- Over-voltage, over-current, and over-temperature protection
- Start-up at -40°C ambient temperature
- Medical and ITE safety approvals
- 2X MOPP, type BF ready
- High efficiency: 93% typical
- > 2.2 Mhrs MTBF
- 3-year warranty
- LPX100 enclosure kit available

### Electrical Specifications

Input	
Input Range	90 to 264 VAC
Frequency	47 to 63 Hz (360 to 440 Hz)
Inrush Current	70 Apk < 1 ms (cold start)
Efficiency	93% Typical
Input Fusing	Internal 6.3 A fuses on L and N lines
No Load Power	< 500 mW
Leakage Current	Meets Medical Leakage for both Class I and II
Power Factor and Harmonics	0.99 typical; meets EN61000-3-2
Hold up Time	10 ms @ 225 W

### Environmental Specifications

Operating Temperature	-20 to 70°C (-40°C start-up)
Storage Temperature	-40 to 85°C
Humidity	5% to 90% Non-condensing
Altitude	Operating: Up to 5000 m (3000 for medical) Non-Operating: Up to 16,000 m

Electrical Specifications		
Output Rating	See ordering information below	
Fan Output	12 V @ 500 mA	J2 connector
Output Set Point	±0.5%	Factory set point
Regulation Range	Main Output: ±2% 12 V Fan Output	Combined set point; line and load variations measured at output pins.
Maximum Power	250 W Forced Air (~300 LFM) 155 W Natural Convection (100% power up to 50°C)	Default VR2 position is for forced air operation. Adjust VR2 full counter clockwise for Natural Convection operation.
Peak Current During Natural Convection	+20% of Max Continuous Load Current (natural convection)	Peak should be < 30 s with max duty cycle of 10%
Output Adjustability	-0% / +10%	Adjust via VR1 Trimpot
Over-voltage Protection (OVP)	130% to 150% of Nominal output	Latching; requires AC recycle to restart
Over-current Protection (OCP)	Forced Air: 110% typical Natural Convection: 135% typical	Shutdown; autorecovery
Short Circuit Protection	< 50 mOhm	Shutdown; autorecovery
Over-temperature protection (OTP)	Refer to TRN for component hot spots and temperature limits.	Shutdown; autorecovery with hysteresis
Isolation Voltage	4000 VAC (input to output) 1500 VAC (input to PE; output to PE)	—
5 V Standby Output (-M1 option)	100 mA	Available on 12 V model (CPS253-M1) only

Ordering Information							
Model Number	Output Voltage	Minimum Load	Max Continuous Load (Free Air)	Peak Load (Free Air) <sup>1</sup>	Max Continuous Load (Forced Air) <sup>2</sup>	Regulation	Ripple (p-p)
CPS253-M	12 V	0 A	12.92 A	15.5 A	20.83 A	±2%	120 mV
CPS253-M1	12 V	0 A	12.92 A	15.5 A	20.83 A	±2%	120 mV
CPS255-M	24 V	0 A	6.45 A	7.74 A	10.42 A	±2%	240 mV
CPS258-M	48 V	0 A	3.23 A	3.88 A	5.21 A	±2%	480 mV

<sup>1</sup> Peak load current Not to exceed 30 seconds with maximum 10% duty cycle.

<sup>2</sup> Requires at least 300 LFM of airflow.

Consult the Technical Reference Notes for complete specifications



## CNS650-MU AT A GLANCE

### Total Power

650 W

### # of Outputs

Single

### Output

- 12 to 48 V
- 5 V Standby
- 12 V Fan Output

### Safety

- TUV 62368-1 / 60601-1
- UL/CSA 62368-1 / 60601-1
- CB IEC 62368-1 / IEC 60601-1
- CE EN60601-1-2 / LVD / RoHS
- DEMKO EN60950-1
- CCC

# CNS650-MU

## Open Frame

## 650 Watts AC-DC Power Supply

### SPECIAL FEATURES

- Up to 650 W forced air, 400 W natural convection
- 4" x 6" x 1.54" U-channel construction
- < 500 mW No-load power consumption
- +15% output adjust
- 5 V standby output
- 12 V fan output
- Power\_OK; VIN\_Good; Remote Inhibit; Fan\_Fail; Fan\_Tachco; Remote Sense
- Over-voltage, over-current, and over-temperature protection
- Start-up at -40°C ambient temperature
- Medical and ITE safety approvals
- 2X MOPP, type BF ready
- High efficiency: 93% typical
- Active current share / Built in o-ring
- Digital I<sup>2</sup>C / PMBus protocol
- > 1.3 Mhrs MTBF
- 3-year warranty
- 80 PLUS certified (-ME model)

### Electrical Specifications

Input	
Input Range	90 to 264 VAC 127 to 350 VDC
AC Input Turn-on	87 to 90 VAC
VAC Input Turn-off	80 to 82 VAC
Frequency	47 to 63 Hz (360 to 440 Hz)
Inrush Current	50 Apk (cold start)
Efficiency	93% Typical 100% Load
Input Fusing	Internal 12 A fuses on L and N lines
No Load Power	< 500 mW - main output disabled
Leakage Current	< 300 μA, 264 VAC, 60 Hz
Power Factor and Harmonics	0.99 typical; meets EN61000-3-2
Hold up Time	25 ms @ 400 W

### Environmental Specifications

Operating Temperature	-20 to 80°C (-40°C Start-up)
Storage Temperature	-40 to 85°C
Humidity	5% to 95% Non-condensing
Altitude	Operating: Up to 5000 m (3000 for medical) Non-Operating: Up to 10,000 m



Electrical Specifications		
Output Rating	See ordering information below	
5 V Standby Output	5 V @ 1 A (Nat Convection) 5 V @ 2 A (Forced Air)	J304
Fan Output	12 V @ 0.5 A (Nat Convection) 12 V @ 1.0 A (Forced Air)	J306 or J304
Regulation Range	Main output: ±2% 12 V fan output	Combined set point; line and load variations measured at output pins.
Maximum Power	650 W Forced Air (~400 LFM) 400 W Nat Convection (-MU Suffix) 360 W Nat Convection (-MF Suffix)	Power Derating applies > 50°C ambient
Peak Load	750 W Forced Air (~400 LFM)	Any duty cycle for as long as Pout Average ≤ 650 W
Output Adjustability	-0% / +15%	Adjust via VR408 Trimpot
Over-voltage Protection (OVP)	130% to 150% of Nominal output	Latching; requires AC recycle to restart
Over-current Protection (OCP)	115% to 170% of rated output current	Constant current up to 50% of rated O/P Voltage then goes to hiccup mode. Autorecovers when fault is removed.
Short Circuit Protection	< 50 mOhm	Hiccup/Non Latching; autorecovery
Over-temperature Protection (OTP)	Refer to TRN for component hot spots and temperature limits	Shutdown; autorecovery with hysteresis
Isolation Voltage	4000 VAC (input to output) 1500 VAC (input to PE; output to PE)	—

Ordering information									
Model Number	Output Voltage	Vout Adjust Range (-0%/+15%)	Minimum Load	Max Continuous Load (Free Air)	Max Peak Load (Free Air) <sup>1</sup>	Max Continuous Load (Forced Air) <sup>2</sup>	Max Peak Load (Forced Air) <sup>2</sup>	Regulation <sup>3</sup>	Ripple (p-p) <sup>4</sup>
CNS653-ME <sup>5,6</sup>	12 V	12 to 13.8 V	0 A	54.2 A	62.5 A	NA	NA	±2%	120 mV
CNS653-MF <sup>5</sup>	12 V	12 to 13.8 V	0 A	30.0 A	54.2 A	54.2 A	62.5 A	±2%	120 mV
CNS653-MU	12 V	12 to 13.8 V	0 A	33.3 A	54.2 A	54.2 A	62.5 A	±2%	120 mV
CNS655-MU	24 V	24 to 27.6 V	0 A	16.7 A	27.1 A	27.1 A	31.3 A	±2%	240 mV
CNS658-MU	48 V	48 to 55.2 V	0 A	8.3 A	13.5 A	13.5 A	15.6 A	±2%	480 mV

<sup>1</sup> Peak load current Not to exceed 10 seconds, T<sub>a</sub> = 50°C.

<sup>2</sup> Requires at least 400 LFM of airflow.

<sup>3</sup> At 25°C including factory setpoint, line voltage and load current variations.

<sup>4</sup> Peak-to-peak ripple measured at the output terminal with 20 MHz bandwidth and 10 µF (tantalum capacitor) in parallel with 0.1 µF capacitor across the output.

<sup>5</sup> Optional suffix "-ME" (end-fan) and "-MF": (open-frame) available on the 12 V output.

<sup>6</sup> 80 PLUS certified.

Consult the Technical Reference Notes for complete specifications



## LCC250 AT A GLANCE

### Total Power

250 W

### # of Outputs

Single

### Output

12 V, 24 V, 48 V

### Size

4" x 7" x 1.1"

### Compliance

- EMI Class B
- EN61000 Immunity

### Safety

- UL + CSA 60950-1  
ANSI ES60601-1 3rd Ed.
- TÜV 62368-1 / 60601-1 /  
61347-1; 2-13
- China CCC<sup>1</sup>
- CB Scheme IEC 62368-1 /  
IEC 61347-1; 2-13 /  
IEC 60601-1

<sup>1</sup> China CCC approval applies to part numbers with "-xxE" suffixes only.

# LCC250

## Convection/Conduction Mounting 250 Watts

### SPECIAL FEATURES

- Wide operating temperature range suited for both outdoor and indoor applications
- 250 W fanless power supply with zero derating up to 85°C baseplate
- IP64 rated enclosure
- Conduction or convection mounting
- Differential remote sense
- Output adjust
- Output on/off (Positive or negative logic user selectable)

### Electrical Specifications

Input	
Input Range	90 to 264 VAC (Operating), 115/230 VAC (Nominal)
Frequency	47 to 63 Hz
Input Fusing	Internal fuse on both L and N lines
Inrush Current	50 A
Power Factor	> 0.92 full load
Harmonics	Meets EN61000-3-2; MIL-STD-461E: CE101; CE102 <sup>1</sup> ; CS101; CS104
Input Current	3.4 A @ 90 VAC full load
Hold up Time	16 ms minimum at 115 VAC; 100% load
Efficiency	230 VAC; 100% load 12 V: 89% typical 24 V: 91% typical 48 V: 91.5% typical
Leakage Current	< 275 µA at 230 VAC

### Environmental Specifications

Operating Temperature	Suffix 4P (conduction): -40 to +85°C baseplate temperature Suffix 7P (convection): -40 to +85°C ambient temperature
Storage Temperature	-40 to +85°C
Humidity	10% to 100% (condensing & Non-condensing)
Altitude	Operating: 13,000 ft Non-operating: 50,000 ft
Shock	IEC 68-2-27
Vibration	IEC 68-2-6 / IEC 721-3-2
Ingress Protection	IP64 rated
MTBF (calculated)	> 780,000 hours at 100% load; Low line; Telcordia SR332

<sup>1</sup> 12 V output compliance to CE102 requires external filter. Consult Technical Reference Notes.

Electrical Specifications		
Output Rating	12 V @ 20.83 A; 24 V @ 10.4 A; 48 V @ 5.2 A	—
Set Point	±0.2%	Factory set point
Total Regulation Range	±2%	Line/load/temperature
Rated Load	250 W maximum	—
Minimum Load	0 A Load	No loss of regulation
Capacitive Load	0 to 330 μF/amp	—
Constant Output Voltage Adjustment Range	12 V: +10/-10%; 24 V: +14.6/-15%; 48 V: +15%/-15%	Adjust via VR2
Constant Output Current Adjustment Range	+0/-50%	Adjust via VR1 CC mode supported from Vo nominal down to 80% Vo
Output Ripple And Noise	1%	See Note 1
Transient Response	±5% Vo max transient; recovery < 500 μs max	50% load step @ 1 A/μs Step load verified at: 50% to 100% load; 90 to 264 VAC input; capacitive load from 0 to 330 μF/Amp
Remote Sense	Capable of stable offset of ±0.5 VDC at output cable termination	+SENSE (red wire); -SENSE (black wire)
Output On/Off	Remote on/off referenced to secondary side. Positive or negative logic user selectable via CN2. Factory default is positive logic.	On/off (orange wire); on/off return (white wire)
Over-load Protection (OCP)	< 150% Io	Autorecovery
Over-voltage Protection (OVP)	110% to 135% Vo	Latching mode; requires input AC recycle
Over-temperature Protection (OTP)	—	Autorecovery; hiccup mode
Output Isolation	4000 VAC Input to Output; 1500 VAC Input to Ground; 500 VAC Output to Ground	—

Ordering Information						
Model Number	Output	Adjustment Range	Output Current		Output Ripple P/P <sup>1</sup>	Combined Line/ Load Regulation
			Min	Max		
LCC250-12U-4P	12 V	±10%	0 A	20.8 A	1%	±2%
LCC250-12U-4PE <sup>3</sup>	12 V	±10%	0 A	20.8 A	1%	±2%
LCC250-12U-7P	12 V	±10%	0 A	20.8 A	1%	±2%
LCC250-12U-7PE <sup>3</sup>	12 V	±10%	0 A	20.8 A	1%	±2%
LCC250-24U-4P	24 V	+14.6/-15%	0 A	10.4 A	1%	±2%
LCC250-24U-4PE <sup>3</sup>	24 V	+14.6/-15%	0 A	10.4 A	1%	±2%
LCC250-24U-7P	24 V	+14.6/-15%	0 A	10.4 A	1%	±2%
LCC250-24U-7PE <sup>3</sup>	24 V	+14.6/-15%	0 A	10.4 A	1%	±2%
LCC250-48U-4P	48 V	±15%	0 A	5.2 A	1%	±2%
LCC250-48U-4PE <sup>3</sup>	48 V	±15%	0 A	5.2 A	1%	±2%
LCC250-48U-7P	48 V	±15%	0 A	5.2 A	1%	±2%
LCC250-48U-7PE <sup>3</sup>	48 V	±15%	0 A	5.2 A	1%	±2%

<sup>1</sup> Output ripple measured at the end of the output cable terminated with 10 μF tantalum capacitor in parallel with 0.1 μF ceramic capacitor.  
<sup>2</sup> Additional external capacitance required to meet the indicated Output Ripple Limits. Please check the Technical Reference Notes.  
<sup>3</sup> China CCC approval applies to part numbers with “-xxE” suffixes only.  
<sup>4</sup> 12 V output compliance to CE102 requires external filter. Consult Technical Reference Notes.



## LCC600 AT A GLANCE

### Total Power

600 W

### # of Outputs

Single

### Output

12 V, 28 V, 36 V, 48 V

### Size

4" x 9" x 1.57"

### Safety

- UL + CSA 60950-1 / 60601-1 3rd Ed
- TÜV 62368-1 / 60601-1
- China CCC
- CB Scheme 62368-1 / 60601-1 Certs
- UL 8750 / TUV EN 61347-1; -2-13 / IEC 61347-1; -2-13 (48 V output)

# LCC600

## Convection/Conduction Mounting 600 Watts

### SPECIAL FEATURES

- Baseplate cooled
- -40 to 85°C operating baseplate temperature
- No derating up to 85°C baseplate temperature
- Adjustable output
- 10.6 watts per in<sup>3</sup>
- Differential remote sense
- EMI Class B
- With +5 V standby @ 1.5 A
- Full DSP controlled
- Optional IP65 ("4P" suffix) variant
- Optional 277 VAC Nominal input ("H" suffix) variant
- Active Ishare
- PMBus™
- Industrial/Medical safety (Suited for BF Type applications)

### Electrical Specifications

Input	
Input Range	90 to 264 VAC (U version) 180 to 305 VAC (H version)
Frequency	50/60/440 Hz (Agency Approval 47 to 63 Hz)
Input Fusing	12.5 A RMS on both input lines (U Suffix)
Inrush Current	< 25 A peak
Power Factor	0.99 typical
Harmonics	Meets EN61000-3-2, Class A and C MIL-STD-461F EMI: CE101, CE102, CS101, CS114, CS115 (w/ ext filter)
Input Current	< 10 Arms max at 100 VAC
Hold up Time	20 ms (main O/P @ 230 VAC)
Isolation	PRI-SEC: 4kVAC (2X MOPP) PRI-CASE: 1.5kVAC (1X MOPP) SEC-CASE: 1.5kVAC (1X MOPP)

### Environmental Specifications

Operating Temperature	-40 to 85°C baseplate
Humidity	10% to 95%
Altitude	5000 m (16,402 ft) operating
Shock	MIL-STD-810F 516.5 Procedure I, VI
Vibration	MIL-STD-810F 514.5 CAT 4, 10
IP Rating	Optional IP65 rated enclosure ("4P" suffix)
MTBF	> 2 MHrs, 25°C per SR-332 Issue 3

Ordering information											
Model Number <sup>1</sup>	AC Input	Output Setpoint (V)	Setpoint Tolerance	Adjustment Range	Output Current [A]		Max O/P Power [W]	Typical Efficiency <sup>2</sup>	Standby Output	Combined Line/Load Regulation	Output Ripple
					Min	Max					
LCC600-48U-9P	90 to 264	48	±0.5%	44 to 54	0	12.5	600	93%	5 VDC @ 1.5 A	2%	1%
LCC600-48H-9P	180 to 305	48	±0.5%	44 to 54	0	12.5	600	93%	5 VDC @ 1.5 A	2%	1%
LCC600-36U-9P	90 to 264	36	±0.5%	32 to 38	0	16.7	600	92%	5 VDC @ 1.5 A	2%	1%
LCC600-36H-9P	180 to 305	36	±0.5%	32 to 38	0	16.7	600	92%	5 VDC @ 1.5 A	2%	1%
LCC600-28U-9P	90 to 264	28	±0.5%	24 to 30	0	25	600	93.5%	5 VDC @ 1.5 A	2%	1%
LCC600-28H-9P	180 to 305	28	±0.5%	24 to 30	0	25	600	93.5%	5 VDC @ 1.5 A	2%	1%
LCC600-12U-9P	90 to 264	12	±0.5%	12 to 15	0	50	600	92%	5 VDC @ 1.5 A	2%	1%
LCC600-12H-9P	180 to 305	12	±0.5%	12 to 15	0	50	600	92%	5 VDC @ 1.5 A	2%	1%

- <sup>1</sup> Change suffix "-9P" to "-4P" for IP65 rated enclosure with fly lead wires.  
Change suffix "-4P" to "-4PR" for IP65 rated enclosure with right angle fly lead wires (applies to 28 V, 36 V, 48 V).  
Change suffix "-4P" to "-4PV" for cables without control signal (applies to 28 V, 36 V and 48 V).
- <sup>2</sup> Typical Efficiency at high line, factory default voltage and full load.
- <sup>3</sup> When the output voltage is set as low as 24 V, it can provide a current of up to 25 A (the maximum power is 600 W).  
At the default output voltage of 28 V, the output current is up to 21.43 A (the maximum power is 600 W).



# CoolX<sup>®</sup> 600 Series

Fanless, Natural Convection-Cooled Modular Power Supply

## SPECIAL FEATURES

### No Fan Featured

- 600 W with 100% natural convection cooling
- No base plate needed
- No acoustic Noise or vibrations

### Reliability

- MTBF > 400,000 hours, 25% better than today's leading solutions
- High input surge protection — 4 kV line to PE for harsh environments
- Reverse energy protection — No blocking diodes required
- 24 W always ON auxiliary power output

- Safety approved to 5000 m altitude
- > 94% efficiency
- Five-year warranty

### Flexibility

- Analog and digital management — PMBus™ monitoring and control capability
- Field-configurable — plug and play power
- Series and parallel outputs — higher voltages/currents
- Mounting options — base/side and DIN-Rail mounting

## Total Power

- CX06S 600 W
- CX06M 600 W

## Slots

4

## Safety

### Medical

- IEC60601-1 3rd edition,
  - IEC60601-1-2 4th edition (EMC)
- 2 MOPP
- Dual fused
- ISO13485

### Industrial

- IEC60950, IEC62368-1
- ISO9000
- SEMI F47<sup>1</sup>

### Defense/Aero

- MIL-STD-810G

<sup>1</sup> SEMI F47 compliant at input voltages > 180 VAC. Consult Advanced Energy for details.

## TYPICAL APPLICATIONS

### Medical

- Clinical diagnostic equipment, medical lasers, dialysis equipment, radiological imaging, clinical chemistry

### Hi Rel

- Harsh industrial electronics, radar (naval and ground-based), communications, test and measurement

### Industrial

- Test and measurement, industrial machines, automation equipment, printing, telecommunications, audio equipment

Environmental Specifications	
Operating Temperature	Operates to specification below -20°C after 10 min warm-up, -40 to 85°C
Storage Temperature	-40 to 85°C
Derating	See derating curves
Relative Humidity	Non-condensing, 5 to 95% RH
Shock and Vibration	MIL-STD-810G Method 514.6
Altitude	5000 m

CoolX CoolMods Table				
Single Output Modules (1 Slot)	Vnom (V)	Set Point Adjust Range (V)	I <sub>max</sub> (A)	Power (W)
CmA	5	2.5 to 6.0	21.0	105
CmB <sup>1</sup>	12	6.0 to 15.0 <sup>2</sup>	15.0	180
CmC	24	15.0 to 28.0	8.3	200
CmD	48	28.0 to 58.0 <sup>3</sup>	4.2	200
High Power Modules (3 Slot)				
CmE <sup>4</sup>	24	24 to 25.2	25.0	550 <sup>7</sup>
CmF <sup>4</sup>	48	48 to 50.4	12.5	550 <sup>7</sup>
Dual Output Modules (1 Slot)				
CmG <sup>5</sup>	V1	24	3.0 to 30.0	90
	V2	24	3.0 to 30.0	90
CmH <sup>6</sup>	V1	5	3.0 to 6.0	36
	V2	24	3.0 to 30.0	90
Wide Trim Modules (1 Slot)				
CmA-W01	5	1.0 to 6.0	21	105
CmB-W01	12	1.0 to 15.0 <sup>2</sup>	15	180
CmC-W01	24	2.0 to 28.0	8.33	200
CmD-W01	48	3.0 to 58.0 <sup>3</sup>	4.17	200

- <sup>1</sup> Full dynamic specifications may Not be met at full load when output voltage is trimmed above 13 V.
- <sup>2</sup> Max Trim 14 V when used with High Power Module
- <sup>3</sup> Max Trim 56 V when used with High Power Module
- <sup>4</sup> a) Only one High Power module (CmE or CmF) can be used per CoolPac.  
b) During load transients starting from 0% load on the High Power modules, other modules in the CoolPac may experience an output voltage dynamic during the load change.
- <sup>5</sup> For the CmG module the max combined power of both outputs is 120 W.
- <sup>6</sup> For the CmH module the max combined power of both outputs is 100 W.
- <sup>7</sup> Max Power of coolPac is 550 W when High Power Module is used



# CoolX<sup>®</sup> 1000 Series

Fanless, Intelligent 1000 W Modular Power Supplies

## SPECIAL FEATURES

### No Fan Featured

- 600 W with 100% natural convection cooling
- No base plate needed
- No acoustic Noise or vibrations

### Reliability

- MTBF > 400,000 hours, 25% better than today's leading solutions
- High input surge protection — 4 kV line to PE for harsh environments
- Reverse energy protection — No blocking diodes required
- 24 W always ON auxiliary power output

- Safety approved to 5000 m altitude
- > 94% efficiency
- Five-year warranty

### Flexibility

- Analog and digital management — PMBus™ monitoring and control capability
- Field-configurable — plug and play power
- Series and parallel outputs — higher voltages/currents
- Mounting options — base/side and DIN-Rail mounting

## Total Power

- CX10S 1000 W
- CX10M 1000 W

## Slots

6

## Safety

### Medical

- IEC60601-1 3rd edition, IEC60601-1-2 4th edition (EMC)
- 2 MOPP
- Dual fused
- SEMI F47<sup>1</sup>

### Industrial

- IEC60950, IEC62368-1
- ISO9001:2015

### Defense/Aero

- MIL-STD-810G

1. SEMI F47 compliant at input voltages > 180 VAC. Consult Advanced Energy for details.

## TYPICAL APPLICATIONS

### Medical

- Clinical diagnostic equipment, medical lasers, dialysis equipment, radiological imaging, clinical chemistry

### Hi Rel

- Harsh industrial electronics, radar (naval and ground-based), communications, test and measurement

### Industrial

- Test and measurement, industrial machines, automation equipment, printing, telecommunications, audio equipment

Environmental Specifications	
Operating Temperature	Operates to specification below -20°C after 10 min warm-up, -40 to 85°C
Storage Temperature	-40 to 85°C
Derating	See derating curves included in the CoolX1000 Designers Manual
Relative Humidity	Non-condensing, 5 to 95% RH
Shock and Vibration	MIL-STD-810G Method 514.6
Altitude	Max 5000 m



CoolX CoolMods					
Single Output Modules (1 Slot)	Vnom (V)	Set Point Adjust Range (V)	I <sub>max</sub> (A)	Power (W)	
CmA	5	2.5 to 6.0	21.0	105	
CmB <sup>1</sup>	12	6.0 to 15.0 <sup>2</sup>	15.0	180	
CmC	24	15.0 to 28.0	8.3	200	
CmD	48	28.0 to 58.0 <sup>3</sup>	4.17	200	
High Power Modules (3 Slot)					
CmE <sup>4</sup>	24	24 to 25.2	25.0	600	
CmF <sup>4</sup>	48	48 to 50.4	12.50	600	
Dual Output Modules (1 Slot)					
CmG <sup>5</sup>	V1	24	3.0 to 30.0	3.0	90
	V2	24	3.0 to 30.0	3.0	90
CmH <sup>6</sup>	V1	5	3.0 to 6.0	6.0	36
	V2	24	3.0 to 30.0	3.0	90
Wide Trim Modules (1 Slot)					
CmA-W01	5	1.0 to 6.0	21	105	
CmB-W01	12	1.0 to 15.0 <sup>2</sup>	15	180	
CmC-W01	24	2.0 to 28.0	8.33	200	
CmD-W01	48	3.0 to 58.0 <sup>3</sup>	4.17	200	

- <sup>1</sup> Full dynamic specifications may Not be met at full load when output voltage is trimmed above 13 V.
- <sup>2</sup> Max Trim 14 V when used with High Power Module
- <sup>3</sup> Max Trim 56 V when used with High Power Module
- <sup>4</sup> a) Only one High Power module (CmE or CmF) can be used per CoolPac.  
b) During load transients starting from 0% load on the High Power modules, other modules in the CoolPac may experience an output voltage dynamic during the load change.
- <sup>5</sup> For the CmG module the max combined power of both outputs is 120 W.
- <sup>6</sup> For the CmH module the max combined power of both outputs is 100 W.



# CS1000 Series

## Fanless, 1U, High Efficiency 1000 W Single Output Power Supplies

### SPECIAL FEATURES

#### No Fan Featured

- 1000 W with 100% natural convection cooling
- No base plate needed
- No acoustic noise or vibrations

#### Reliability

- High input surge protection — 4 kV line to PE for harsh environments
- Reverse energy protection — No blocking diodes required
- User selectable (5 V / 12 V) 24 W always ON auxiliary power output
- N+1 Redundancy Ready

- Can be paralleled for higher power
- Optional low leakage (<150 uA)
- Safety approved to 5000 m altitude
- Programmable start-up state (Default ON or Default OFF)
- > 94% efficiency
- Five-year warranty

#### Flexibility

- Analog and digital management — PMBus™ monitoring and control capability
- Mounting options: base/side and DIN-Rail mounting

### Total Power

- CS10S 1000 W
- CS10M 1000 W

### Output Voltage

24 V, 48 V

### Safety

#### Medical

- IEC60601-1 3rd edition,
- 2 MOPP
- Dual fused

#### Industrial

- IEC62368-1
- ISO9001:2015
- SEMI F47<sup>1</sup>

1. SEMI F47 compliant at input voltages > 180 VAC. Consult Advanced Energy for details.

### TYPICAL APPLICATIONS

#### Medical

- Clinical diagnostic equipment, medical lasers, dialysis equipment, radiological imaging, clinical chemistry

#### Hi Rel

- Harsh industrial electronics, radar (naval and ground-based), communications, test and measurement

#### Industrial

- Test and measurement, industrial machines, automation equipment, printing, telecommunications, audio equipment

### Environmental Specifications

Operating Temperature	Operates to specification below -20°C after 10 min warm-up, -40 to 85°C
Storage Temperature	-40 to 85°C
Derating	See derating curves
Relative Humidity	Non-condensing, 5 to 95% RH
Altitude	Max 5000 m
Vibration	810G: Method 514.6, Procedure I (General Vibration). Category 4 Common Carrier (US Highway truck vibration exposure) Fig.514.6C-1. Category 4 Composite 2 wheeled trailer vibration exposure, Fig.514.6C-2. Category 4 Composite wheeled vehicle vibration exposure, Fig.514.6C-3.

## FANLESS/CONDUCTION COOLED

	CS1000-24	CS1000-48
Power (W)	1000	1000
Output Voltage (V)	24	48
Output Current (A)	41.6	20.8
Medical Approval UL/EN60601-1, 3rd Edition	Yes	Yes
Industrial Approval UL/EN62368, 2nd Edition	Yes	Yes
Vnom (V)	24	48
Description	Convection-cooled U-channel	Convection-cooled U-channel
Output Adjustment Range (V)	22 to 28	44 to 56
Dynamic Vtrim Range (V)	22 to 28	44 to 56
Iout I <sub>max</sub> (A)	41.6	20.8
Remote Sense	Yes	Yes
Power Good	Yes	Yes
AC Good	Yes	Yes

## LOW POWER

# Low Power

## External Power Adapters

### 10 to 100 Watts

### SPECIAL FEATURES

#### All Models Feature

- Wide-range AC input
- High demonstrated MTBF
- Over-load protection
- Extensive safety approvals

#### Many Models Feature



- EN61000-3-2 compliance
- Medical approvals
- Thermal protection
- Energy Star/ErP
- DoE Level VI
- EU CoC v5 Tier 2

#### AC Input

- Wallmount
  - U.S. – 2-prong
  - China – 2-prong
  - Europe – 2-prong
  - United Kingdom – 3-prong
  - Australia – 2-prong
  - Korea – 2-prong
  - Japan – 2-prong
  - Interchangeable
- Freestanding
  - IEC320 3-pin (C14) & (C6)

#### DC Output

- Single output
  - 2.5 mm barrel plug

Low Power					
Output Power	Output			Size W x L x H (mm)	Model
	V1	V2	V3		
<b>10 W</b>	<b>DA10-M Series (Level VI)</b>				
	5 V @ 2 A			1.10" x 2.36" x 2.14" (28 x 60 x 54.3)	DA10-050AU-M
	5 V @ 2 A			1.10" x 2.36" x 2.48" (28 x 60 x 63.1)	DA10-050EU-M
	5 V @ 2 A			1.98" x 2.36" x 1.90" (50.2 x 60 x 48.3)	DA10-050UK-M
	5 V @ 2 A			1.10" x 2.36" x 1.99" (28 x 60 x 50.6)	DA10-050US-M
	5 V @ 2 A			1.1" x 2.36" x 2.06" (28 x 60 x 52.3)	DA10-050MP-M <sup>1</sup>
	5 V @ 2 A			1.1" x 2.36" x 2.06" (28 x 60 x 52.3)	DA10-050MP-M2.1 <sup>2</sup>
	5 V @ 2 A			1.1" x 2.36" x 2.06" (28 x 60 x 52.3)	DA10-050MP-M402 <sup>3</sup>
<b>24 W</b>	<b>AD24 (Level VI)</b>				
	12 V @ 2 A			1.89" x 4.13" x 1.3" (48 x 105 x 33)	AD2412N3L-VI
<b>100 W</b>	<b>DP100 Series (Level VI &amp; PoE Isolation)</b>				
	54 V @ 1.85 A			6.14" x 2.56" x 1.46" (156 x 65 x 37.2)	DP10054P3L

#### Options

- <sup>1</sup> Interchangeable AC plug — must be purchased separately
- <sup>2</sup> 2.1 x 5.5 mm barrel plug
- <sup>3</sup> μUSB connector

# Healthcare AC-DC Power Supplies

## Up to 24,000 Watts

Advanced Energy produces a wide range of AC-DC power supplies certified for use in medical equipment requiring lower safety ground leakage and higher isolation. The power supplies listed below are designed for use in Non-patient critical applications: bio-life science, medical, dental, imaging and laboratory applications such as immunoassay and in-vitro diagnostics machines, ultrasound, and mass analyzers. All of these power supplies are high efficiency switch-mode designs and feature medical safety approval to EN60601-1.



### SPECIAL FEATURES

#### All Models Feature

- Industry standard footprints
- Wide-range AC input
- Remote sense
- Adjustable outputs
- Power fail
- Full power to 50°C
- High demonstrated MTBF
- Over-voltage protection
- Over-load protection
- Built-in EMI filtering
- Medical approvals
- Extensive safety approvals
- Derated operation to 70°C

#### Many Models Feature

- EN61000-3-2 compliance
- Supervisory outputs (5 V/12 V)
- Wide-adjust floating 4<sup>th</sup> output
- Single wire current share
- Wide-adjust on single output models
- Voltage monitor/data logging
- Real-time parametric adjustment & control







Healthcare AC-DC Power Supplies							
Output Power		Output					
[Forced Air]	Free Air	V1	V2	V3	V4	Size W x L x H (mm)	Model
[40 W]	25 W	NPS20-M Series <sup>3</sup>					
1		5 V @ 5 A [8 A] <sup>2</sup>				2" x 4" x 1" (50.8 x 101.6 x 25.4)	NPS22-M
		12 V @ 2.1 A [3.3 A] <sup>2</sup>					NPS23-M
		15 V @ 1.7 A [2.7 A] <sup>2</sup>					NPS24-M
		24 V @ 1 A [1.8 A] <sup>2</sup>					NPS25-M
		48 V @ 0.52 A [0.84 A] <sup>2</sup>					NPS28-M
[55 W]	40 W	LP40-M Series <sup>3</sup>					
1		5 V @ 8 A [11 A] <sup>2</sup>				3" x 5" x 1.2" (76.2 x 127 x 30.5)	LPS42-M
		12 V @ 3.3 A [4.5 A] <sup>2</sup>					LPS43-M
		15 V @ 2.6 A [3.6 A] <sup>2</sup>					LPS44-M
		24 V @ 1.6 A [2.3 A] <sup>2</sup>					LPS45-M
		5 V @ 4 A [5 A]	12 V @ 2 A [2.5 A]	-12 V @ 0.5 A [0.7 A]			LPT42-M
		5 V @ 4 A [5 A]	15 V @ 2 A [2.5 A]	-15 V @ 0.5 A [0.7 A]			LPT45-M
[60 W]	45 W	NPS40-M Series <sup>3</sup>					
1		5 V @ 8 A [11 A] <sup>2</sup>				2" x 4" x 1" (50.8 x 101.6 x 25.4)	NPS42-M
		12 V @ 3.75 A [5 A] <sup>2</sup>					NPS43-M
		15 V @ 3 A [4 A] <sup>2</sup>					NPS44-M
		24 V @ 1.9 A [2.5 A] <sup>2</sup>					NPS45-M
		48 V @ 0.94 A [1.25 A] <sup>2</sup>					NPS48-M

**Options**

- [ ] Rating with 30 CFM of air
- 1 Optional cover/enclosure
- 2 Floating output

3 This product is a component power supply and is only for inclusion by professional installers within other equipment and must Not be operated as a standalone product. EMC compliance to appropriate standards must be verified at the system level. This product is for sale to OEMs and system integrators, including through distribution channels. It is Not intended for sale to end users.

## HEALTHCARE AC-DC POWER SUPPLIES

Healthcare AC-DC Power Supplies							
Output Power		Output				Size W x L x H (mm)	Model
[Forced Air]	Free Air	V1	V2	V3	V4		
[55 W]	45 W	<b>NPT40-M Series<sup>3</sup></b>					
1		5 V @ 5 A [8 A]	12 V @ 2.5 A [3 A]	-12 V @ 0.5 A [0.7 A]			NPT42-M
		5 V @ 5 A [8 A]	15 V @ 2 A [2.4 A]	-15 V @ 0.5 A [0.7 A]			NPT43-M
		5 V @ 5 A [8 A]	24 V @ 1 A [1.5 A]	12 V @ 0.5 A [0.7 A]			NPT44-M
[60 W]	60 W	<b>NPS60-M Series<sup>3</sup></b>					
1		5 V @ 11 A <sup>2</sup>				2" x 4" x 1"	NPS62-M
		12 V @ 5 A <sup>2</sup> (Level VI Efficiency)					NPS63-M-006
		15 V @ 4 A <sup>2</sup>					NPS64-M
		24 V @ 2.5 A <sup>2</sup>					NPS65-M
[80 W]	60 W	<b>LP60-M Series<sup>3</sup></b>					
1		12 V @ 5 A [6.7 A] <sup>2</sup>				3" x 5" x 1.65" (76.2 x 127 x 41.9)	LPS63-M
		15 V @ 4 A [5.3 A] <sup>2</sup>					LPS64-M
		24 V @ 2.5 A [3.3 A] <sup>2</sup>					LPS65-M
		5 V @ 7 A [8 A]	12 V @ 3 A [3.5 A]	-12 V @ 0.7 A [1 A]			LPT62-M
		5 V @ 7 A [8 A]	15 V @ 2.8 A [3.3 A]	-15 V @ 0.7 A [1 A]			LPT63-M
[130 W]		<b>LPT100-M Series<sup>3</sup></b>					
1		3.3 V @ [18 A]	5 V @ [9 A]	12 V @ [2.3 A]		2" x 4" x 1.28" (50.8 x 101.6 x 32.7)	LPT101-M
		5 V @ [18 A]	12 V @ [9 A]	-12 V @ [2 A]			LPT102-M
		5 V @ [18 A]	15 V @ [7.2 A]	-15 V @ [1.5 A]			LPT103-M
		5 V @ [18 A]	24 V @ [3 A]	12 V @ [2.3 A]			LPT104-M
[150 W]	100 W	<b>LPS100-M Series<sup>3</sup></b>					
1		5 V @ 16 A [24 A] <sup>2</sup>				2" x 4" x 1.29" (50.8 x 101.6 x 33)	LPS102-M
		12 V @ 8.3 A [12.5 A] <sup>2</sup>					LPS103-M
		15 V @ 6.7 A [10 A] <sup>2</sup>					LPS104-M
		24 V @ 4.2 A [6.3 A] <sup>2</sup>					LPS105-M
		48 V @ 2.1 A [3.1 A] <sup>2</sup>					LPS108-M
		54 V @ 1.85 A [2.8 A] <sup>2</sup>					LPS109-M
[150 W]	100 W	<b>TLP150 Series<sup>3</sup></b>					
1		12 V @ 12.5 A <sup>2</sup>				3" x 5" x 1.25"	TLP150N-99S12J <sup>4</sup>
		24 V @ 6.3 A <sup>2</sup>				(177.8 x 101.6 x 31.75)	TLP150N-99S24J <sup>4</sup>

### Options

[ ] Rating with 30 CFM of air

<sup>1</sup> Optional cover/enclosure (see datasheet for increased dimensions)

<sup>2</sup> Floating output

<sup>3</sup> This product is a component power supply and is only for inclusion by professional installers within other equipment and must Not be operated as a standalone product. EMC compliance to appropriate standards must be verified at the system level. This product is for sale to OEMs and system integrators, including through distribution channels. It is Not intended for sale to end users.

<sup>4</sup> Replace the 'J' at the end of the model number with 'FJ' when the optional standby output and/or remote ON/OFF control is required e.g., TLP150N-99S12FJ

Healthcare AC-DC Power Supplies							
Output Power		Output				Size W x L x H (mm)	Model
[Forced Air]	Free Air	V1	V2	V3	V4		
[175 W]	110 W	<b>LP170-M Series<sup>3</sup></b>					
1 		5 V @ 22 A [35 A] <sup>2</sup> (2.5 to 6 V)				4.25" x 8.5" x 1.5" (108 x 215.9 x 38.1)	LPS172-M
		12 V @ 9.1 A [15 A] <sup>2</sup> (6 to 12 V)					LPS173-M
		15 V @ 7.3 A [12 A] <sup>2</sup> (12 to 24 V)					LPS174-M
		24 V @ 4.5 A [7.5 A] <sup>2</sup> (24 to 54 V)					LPS175-M
[200 W]	100 W	<b>LPQ200-M Series<sup>3</sup></b>					
1 		3.3 V @ 13 A [18 A]	5 V @ 13 A [18 A]	12 V @ 5 A [9 A]	-12 V @ 1 A [2 A]	3" x 5" x 1.32" (76.2 x 127 x 33.6)	LPQ201-M
		5 V @ 13 A [18 A]	12 V @ 5 A [9 A]	24 V @ 1.5 A [3 A]	-12 V @ 1 A [2 A]		LPQ202-M
[250 W]	125 W	<b>LPS200-M Series<sup>3</sup></b>					
		5 V @ 20 A [40 A] <sup>2</sup>				3" x 5" x 1.32" (76.2 x 127 x 33.6)	LPS202-M
		12 V @ 10.3 A [20.8 A] <sup>2</sup>					LPS203-M
		15 V @ 8.3A [16.6 A] <sup>2</sup>					LPS204-M
		24 V @ 5.2 A [10.4 A] <sup>2</sup>					LPS205-M
		48 V @ 2.6 A [5.2 A] <sup>2</sup>					LPS208-M
[250 W]	155 W	<b>CPS250-M Series<sup>3</sup></b>					
		12 V @ 12.92 A [20.83 A]				2" x 4" x 1.3" (50.8 x 101.6 x 32.8)	CPS253-M
		24 V @ 6.45 A [10.42 A]					CPS255-M
		48 V @ 3.23 A [5.21 A]					CPS258-M
[360 W]	240 W	<b>LPS360-M Series<sup>3</sup></b>					
		12 V @ 20 A [30 A] <sup>2</sup>				3" x 5" x 1.3" (76.2 x 127 x 33)	LPS363-M
		15 V @ 16 A [24 A] <sup>2</sup>					LPS364-M
		24 V @ 10 A [15 A] <sup>2</sup>					LPS365-M
		36 V @ 6.25 A [11.25 A] <sup>2</sup>					LPS366-M
		48 V @ 5 A [7.5 A] <sup>2</sup>					LPS368-M
[250 W]	250 W	<b>LCC250 Series</b>					
		12 V @ 20.8 A				4" x 7" x 1.1" (101.6 x 177.8 x 28)	See LCC250 section
		24 V @ 10.4 A					
		48 V @ 5.2 A					
[600 W]	600 W	<b>LCC600 Series</b>					
		12 V @ 50.0 A				4" x 9" x 1.57" (101.6 x 228.6 x 40)	See LCC600 section
		28 V @ 21.4 A					
		36 V @ 16.7 A					
		48 V @ 12.5 A					
[600 W]	600 W	<b>CoolX600 Series</b>					
		5, 12 V	8 outputs			8.5" x 4.5" x 1U (215.9 x 114.3 x 39.1)	See CoolX600 section

**Options**  
<sup>1</sup> Optional cover/enclosure (see datasheet for increased dimensions)  
<sup>2</sup> Floating output  
<sup>3</sup> This product is a component power supply and is only for inclusion by professional installers within other equipment and must Not be operated as a standalone product. EMC compliance to appropriate standards must be verified at the system level. This product is for sale to OEMs and system integrators, including through distribution channels. It is Not intended for sale to end users.

## HEALTHCARE AC-DC POWER SUPPLIES

Healthcare AC-DC Power Supplies							
Output Power		Output				Size W x L x H (mm)	Model
[Forced Air]	Free Air	V1	V2	V3	V4		
[650 W]	400 W	<b>CNS650 Series<sup>3</sup></b>					
		12 V @ 54.2 A				4" x 7" x 1.6" (101.6 x 177.8 x 40.6)	CNS653-ME
		12 V @ 54.2 A [30.8 A]				3.8" x 6" x 1.3" (101.6 x 152.4 x 34.1)	CNS653-MF
		12 V @ 54.2 A [33.3 A]				4" x 6" x 1.5" (101.6 x 152.4 x 39)	CNS653-MU
		24 V @ 27.1 A [16.7 A]					CNS655-MU
		48 V @ 13.5 A [8.3 A]					CNS658-MU
[300 W]		<b>LCM300 Bulk Front End</b>					
		12 to 60 V	Single outputs			1.61" x 4.0" x 7.0" (4.09 x 101.6 x 177.8)	See LCM300 section
[600 W]		<b>LCM600 Bulk Front End</b>					
		12 to 60 V	Single outputs			4.5" x 7.5" x 2.4" (114.3 x 190.5 x 62)	See LCM600 section
[1000 W]		<b>LCM1000 Bulk Front End</b>					
		12 to 52.8 V	Single outputs			2.5" x 5.2" x 10.0" (63.5 x 132.1 x 254)	See LCM1000 section
[1000 W]		<b>CoolX1000 Series</b>					
		1 to 58 V	12 outputs			10" x 6.5" x 1U (259.5 x 164 x 41)	See CoolX1000 section
[1000 W]		<b>CS1000 Series</b>					
		24, 48 V	Single output			10" x 6.5" x 1U (259.5 x 164 x 41)	See CS1000 section
[1800 W]		<b>CoolX1800 Series</b>					
		1 to 58 V	12 outputs			10.5" x 5" x 1U (262 x 127 x 41)	See CoolX1800 section
[Up to 1200 W]		<b>UltiMod Series</b>					
		1 to 58 V	12 outputs			<b>UX4:</b> 10" x 10.3" x 1U (260 x 89 x 41) <b>UX6:</b> 10" x 5" x 1U (260 x 127 x 41)	See UltiMod section
[1500 W]		<b>LCM1500 Bulk Front End</b>					
		12 to 52.8 V	Single outputs			2.5" x 5.2" x 10.0" (63.5 x 132.1 x 254)	See LCM1500 section



Healthcare AC-DC Power Supplies							
Output Power		Output				Size W x L x H (mm)	Model
[Forced Air]	Free Air	V1	V2	V3	V4		
Up to 1800 W		Micro MP Series					
		1.8 to 60 V	1 to 12 outputs	(Fully Configurable)		3.5" x 10.11" x 1.57" (88.9 x 256.9 x 40)	See μMP section
Up to 1500 W		Intelligent MP Series					
		2 to 60 V	1 to 21 outputs	Fully configurable and intelligent		5" x 10" x 2.5" (127 x 254 x 63.5)	See iMP section
[3000 W]		LCM3000 Bulk Front End					
		12 to 48 V	Single outputs			2.5" x 7.0" x 10.9"	See LCM3000 section
1500 to 4920 W		Intelligent VS Series					
		2 to 60 V	1 to 42 outputs	Fully configurable and intelligent		5" x 11" x 5" (127 x 279.4 x 127)	See iVS section
Up to 24000 W		Precision High Power System					
		0.12 to 300 V	Up to 8 outputs	Fully configurable and intelligent		5.22" x 19" x 27.9" (132.5 x 482.6 x 708.3)	See iHP Section



## UltiMod Series

Unique in Flexibility, Unrivalled in Performance,  
Ultra-cost Competitive

### SPECIAL FEATURES

- Highest efficiency — up to 91%
- User and field configurable
- Standard medical features
- Leakage current < 300  $\mu$ A (< 150  $\mu$ A optional)
- 2 MOPP
- 4 KV Isolation
- Lowest acoustic Noise
- -40°C start-up temperature
- Extra ruggedized optional
- Vibration: MIL-STD-810G
- No minimum load
- Extra-low profile < 1U height
- All outputs fully floating
- Series/parallel of multiple outputs
- 5 V isolated standby voltage
- Active PFC (Power Factor Correction)
- Product options: Conformal coating, low leakage current, connector, cabling and mounting options, and reverse fans additional ruggedization

### Total Power

- UX4 600 W
- UX6 1200 W

### Slots

4, 6

### Safety

#### Medical

- UL/EN60601-1 3rd edition
- UL/EN60601-1-2 4th edition (EMC)

#### Industrial

- UL/EN60950 2nd edition

### TYPICAL APPLICATIONS

#### Medical

- Clinical diagnostic and dialysis equipment, medical lasers, radiological imaging, clinical chemistry

#### Industrial

- Test and measurement, industrial machines, automation and audio equipment, printing, telecommunications

Ordering Information							
Model	Vnom (V)	Set Point Adjust Range	Dynamic Vtrim Range (V)	I <sub>max</sub> (A)	Power (W)	Remote Sense	Power Good
XgA	12.0	10.8 to 15.6	—	12.5	150	—	—
XgB	24.0	19.2 to 26.4	—	8.3	200	—	—
XgC	36.0	28.8 to 39.6	—	5.6	200	—	—
XgD	48.0	38.5 to 50.4	—	4.2	200	—	—
XgE/Xg7	24.0	5.0 to 28.0	—	5.0	120	—	—
XgF/Xg8 (v1)	24.0	5.0 to 28.0	—	3.0	72	—	Yes
(v2)	24.0	5.0 to 28.0	—	3.0	72	—	Yes
XgG	2.5	1.5 to 3.6	1.15 to 3.6	40.0	100	Yes	Yes
XgH	5.0	3.2 to 6.0	1.5 to 6.0	36.0	180	Yes	Yes
XgJ	12.0	6.0 to 15.0	4.0 to 15.0	18.3	220	Yes	Yes
XgK	24.0	12.0 to 30.0	8.0 to 30.0	9.2	220	Yes	Yes
XgL	48.0	28.0 to 58.0	8.0 to 58.0	5.0	240	Yes	Yes
Xg1	2.5	1.5 to 3.6	1.15 to 3.6	50.0	125	Yes	Yes
Xg2	5.0	3.2 to 6.0	1.5 to 6.0	40.0	200	Yes	Yes
Xg3	12.0	6.0 to 15.0	4.0 to 15.0	20.0	240	Yes	Yes
Xg4	24.0	12.0 to 30.0	8.0 to 30.0	10.0	240	Yes	Yes
Xg5	48.0	28.0 to 58.0	8.0 to 58.0	6.0	288	Yes	Yes
XgM	5.0	3.2 to 6.0	1.0 to 6.0	40.0	200	Yes	Yes
XgN	12.0	6.0 to 15.0	1.0 to 15.0	20.0	240	Yes	Yes
XgP	24.0	12.0 to 30.0	1.0 to 30.0 <sup>1</sup>	10.0	240	Yes	Yes
XgQ	48.0	24.0 to 58.0	1.0 to 58.0 <sup>2</sup>	6.0	288	Yes	Yes
XgR	24.0	12.0 to 30.0	8.0 to 30.0	10.0	240	—	Yes
XgT	48.0	28.0 to 58.0	8.0 to 58.0	6.0	288	—	Yes

Environmental Specifications						
Parameter	Conditions/Description	Min	NOM	Max	Units	
Operating Temperature	Operates to specification below -20°C after 10 min warm-up	-40	—	70	°C	
Storage Temperature		-40	—	85	°C	
Derating	See derating curves	—	—	—	—	
Relative Humidity	Non-condensing	5	—	95	% RH	
Acoustic Noise	Measured from distance of 1 m; UX4/UX6. See page 58 of catalog	—	39.8/42.7	—	dBA	
Shock		60	—	—	G	
Vibration	MIL-STD 810G	—	—	—	—	
Altitude	Operational: 2000 m, Storage: 8000 m	—	—	—	—	

<sup>1</sup> SEMI F47 compliant at input voltages > 160 VAC. Consult Advanced Energy for details.

<sup>2</sup> Visit [www.advancedenergy.com](http://www.advancedenergy.com) for configuration, ordering and contact information.

# Intelligent MP Series

Intelligent Modular Power Supply for Optimum Flexibility  
Up to 1500 Watts

## SPECIAL FEATURES

- Medical EN60601-1 approval
- Intelligent I<sup>2</sup>C control
- Voltage adjustment on all outputs (Manual or I<sup>2</sup>C)
- Configurable input and output (case and module) OK signals and indicators
- Configurable inhibit/enable
- Configurable output UP/DOWN sequencing
- Configurable current limit (foldback or constant current)
- High power density (8.8 W/in<sup>3</sup>)
- Intelligent fan (speed control/fault status)
- Downloadable GUI from website
- Customer provided air option
- $\mu$ P controlled PFC input with active inrush protection
- I<sup>2</sup>C monitor of voltage, current and temp
- Programmable voltage, current limit, inhibit/enable through I<sup>2</sup>C
- Optional extended hold-up module (SEMI F47 compliance)
- CAN BUS and RS-485 interface option
- Low leakage (< 300  $\mu$ A)
- Increased power density to 50% over standard MP
- Backward compatibility with standard MP
- External switching frequency sync input
- Optional conformal coating
- Industrial temp range (-40 to 70°C)
- No preload required
- Industrial shock/vibration (> 50 Gs)

### Total Power

Up to 1500 Watts

### Input Voltage

- 85 to 264 VAC
- 120 to 300 VDC

### # of Outputs

Up to 21

### Safety

- UL UL60950/UL2601
- CSA CSA22.2 No. 234 Level 5
- VDE EN60950/EN60601-1
- BABT Compliance to EN60950/EN60601 BS7002
- CB Certificate and report
- CE Mark to LVD

Electrical Specifications	
<b>Input</b>	
Input Range	85 to 264 VAC 120 to 350 VDC (limited to 300 VDC in medical applications)
Frequency	47 to 63 Hz (iMP1 47 to 440 Hz)
Inrush Current	40 A peak max (soft start)
Efficiency	Up to 85% @ full case load
Power Factor	0.99 typ meets EN61000-3-2 (n/a @ 440 Hz)
Turn-on Time	AC on 2 sec typ, inhibit/enable 150 ms typical Programmable delay; 50 ms internal turn-on delay (Dual Output only)
EMI Filter	CISPR 22/EN55022 Level "B"
Leakage Current	300 $\mu$ A max @ 240 VAC; 47 to 63 Hz
Radiated EMI	CISPR 22/EN55022 Level "B"
Holdover Storage	20 ms min (independent of input VAC) additional 34 ms holdover storage with optional HUP module (SEMI F47 compatible)
AC OK	> 5 ms early warning min before outputs lose regulation Full cycle ride thru (50 Hz) (N/A on iMP4 > 750 W @ 90 VAC)
Harmonic Distortion	Meets EN61000-3-2



Electrical Specifications (Continued)	
<b>Input</b>	
Isolation	Meets EN60950 and EN60601 Input to output, input to ground: 2000 VAC; output to ground: 400 VDC Meets 1 MOPP Primary to ground, 2 MOPP Primary to Secondary
Global Inhibit/Enable	TTL, Logic "1" and Logic "0"; configurable
Input Fuse (internal)	iMP4: 16 A; iMP8: 20 A; iMP1: 25 A (both lines fused)
Warranty	Three years
<b>Output</b>	
Adjustment Range <sup>1</sup>	±10% minimum all outputs (manual) (full module adjustment range using I <sup>2</sup> C)
Margining	±4-6% Nominal analog (single output module only)
Overall Regulation	0.4% or 20 mV max (1500 W modules 1% max 36 W modules 4% max)
Ripple	RMS: 0.1% or 10 mV, whichever is greater Pk-Pk: 1.0% or 50 mV, whichever is greater Bandwidth limited to 20 MHz
Dynamic Response	< 2% or 100 mV, with 25% load step
Recovery Time	To within 1% in < 300 μs
Over-current Protection <sup>2</sup>	Configurable through I <sup>2</sup> C (calibration required). Single output module and main output of the dual output module 105 to 120% of rated output current. Aux output of dual output module 105 to 140% of rated output current
Short-circuit Protection	Protected for continuous short-circuit Recovery is automatic upon removal of short
Over-voltage Protection <sup>1</sup>	Configurable through I <sup>2</sup> C
- Single Output Module - Dual Output Module - Triple Output Module	2 to 5.5 V 122 to 134%; 6 to 60 V 110 to 120% 2 to 6 V 122 to 134%; 8 to 28 V 110 to 120%
Reverse Voltage Protection	100% of rated output current
Thermal Protection <sup>1</sup> (OTP and OTW)	Configurable through I <sup>2</sup> C All outputs disabled when internal temp exceeds safe operating range. > 5 ms warning (AC OK signal) before shutdown
Remote Sense	Up to 0.5 V total drop (Not available on triple output module)
Single Wire Parallel	Current share to within 2% of total rated current
DC OK <sup>1</sup>	±5% of Nominal. Configurable through I <sup>2</sup> C
Minimum Load	Not required
Housekeeping Standby	5 VDC @ 1.0 A max present whenever AC input is applied (Optional 2.0 A available)
Module Inhibit <sup>1</sup>	Configured and controlled through I <sup>2</sup> C
Switching Frequency	250 kHz accepts external sync signal
Output/Output Isolation	> 1 Megohm, 500 V

<sup>1</sup> Can be controlled via I<sup>2</sup>C  
<sup>2</sup> Controlled via I<sup>2</sup>C but requires load calibration

Environmental Specifications	
Operating Temperature	-40 to 70°C ambient. Derate each output 2.5% per degree from 50 to 70°C. (-20°C start-up)
Storage Temperature	-40 to 85°C
Electromagnetic Susceptibility	Designed to meet EN61000-4; -2, -3, -4, -5, -6, -8, -11 Level 3
Humidity	Operating; Non-condensing 10% to 95% RH
Vibration	IEC68-2-6 to the levels of IEC721-3-2
MTBF Demonstrated	> 550,000 hours at full load, 220 VAC and 25°C ambient conditions

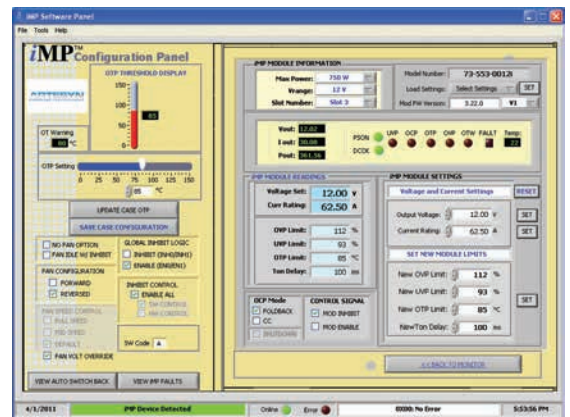

The iMP software is designed to make the iMP Power Supply Unit (PSU) accessible to the user. It is intended to provide information gathered from the PSU and interactive controls to the basic capabilities of iMP power supply.

# INTELLIGENT MEDIUM POWER

Output Module Line-up							
Module Code	1	2	3	5	4		Triple
Module Type	Single	Single	Single	Single	Dual		
Max Output Power	210 W	360 W	750 W	1500 W	144 W		36 W
Max Output Current	35 A	60 A	150 A	300 A	10 A		2 A
Output Voltages Available <sup>1</sup>	2 to 60 V	2 to 60 V	2 to 60 V	2 to 60 V	6 to 15, 24 to 28; 6 to 15; 6 to 15; 6 to 15; 2 to 6; 2 to 6, 2 to 6; 24 to 28, 24 to 28; 24 to 28; 2 to 6		8 to 15, 8 to 15, 2 to 6; 8 to 15, 8 to 15, 8 to 15; 8 to 15, 8 to 15, 18 to 28; 8 to 15, 18 to 28, 2 to 6
Standard Voltage Increments	25	25	25	18	16		18
Remote Sense	Yes	Yes	Yes	Yes	Yes	Yes	No
Remote Margin <sup>1</sup>	Yes	Yes	Yes	Yes	No	No	No
V-Program - I <sup>2</sup> C Control <sup>1</sup>	Yes	Yes	Yes	Yes	Yes	Yes	No
Active Current Share	Yes	Yes	Yes	Yes	Yes	No	No
Module Inhibit - I <sup>2</sup> C Control <sup>1</sup>	Yes	Yes	Yes	Yes	Yes	Yes	Yes
Module Inhibit - Analog	Yes	Yes	Yes	Yes	No	No	No
Over-voltage/Over-current Protection <sup>1</sup>	Yes	Yes	Yes	Yes	Yes	Yes	Yes
Minimum Load Required	No	No	No	No	No	No	No
Slots Occupied in any iMP Case	1	2	3	4	1		1

Output Module Voltage/Current											
Voltage	Voltage Code	Single Output Module Code				Dual Output <sup>3</sup>		Triple Output			I <sup>2</sup> C Adjustment Ranges <sup>4</sup>
		1	2	3	5 <sup>5</sup>	V1	V2				
2 V	A	35 A	60 A	150 A	300 A	10 A	10 A	—	—	2 A	1.8 to 2.2
2.2 V	B	35 A	60 A	150 A	300 A	10 A	10 A	—	—	2 A	2.0 to 2.4
3 V	C	35 A	60 A	150 A	300 A	10 A	10 A	—	—	2 A	2.7 to 3.3
3.3 V	D	35 A	60 A	150 A	300 A	10 A	10 A	—	—	2 A	3.0 to 3.6
5 V	E	35 A	60 A	150 A	300 A	10 A	10 A	—	—	2 A	4.5 to 5.5
5.2 V	F	35 A	60 A	144 A	288 A	10 A	10 A	—	—	2 A	4.7 to 5.7
5.5 V	G	34 A	58 A	136 A	273 A	10 A	10 A	—	—	2 A	5.0 to 6.1
6 V	H	23 A	42 A	97.5 A	250 A	10 A <sup>2</sup>	10 A <sup>2</sup>	—	—	2 A	5.4 to 6.6
8 V	I	20 A	36 A	84.4 A	140 A	10 A	4 A	1 A	1 A	1 A	7.2 to 8.8
10 V	J	18 A	32 A	75 A	140 A	10 A	4 A	1 A	1 A	1 A	9.0 to 11.0
11 V	K	17 A	31 A	68 A	136.3 A	10 A	4 A	1 A	1 A	1 A	9.9 to 12.1
12 V	L	17 A	30 A	62.5 A	125 A	10 A	4 A	1 A	1 A	1 A	10.8 to 13.2
14 V	M	14 A	21 A	53.5 A	107 A	9 A	4 A	1 A	1 A	1 A	12.6 to 15.4
15 V	N	14 A	20 A	50 A	100 A	8 A	4 A	1 A	1 A	1 A	13.5 to 16.5
18 V	O	11 A	19 A	41.6 A	83.3 A	—	—	—	0.5 A	0.5 A	16.2 to 19.8
20 V	P	10.5 A	18 A	37.5 A	75 A	—	—	—	0.5 A	0.5 A	18.0 to 22.0
24 V	Q	8.5 A	15 A	30 A	62.5 A	4 A	2 A	—	0.5 A	0.5 A	21.6 to 26.4
28 V	R	6.7 A	11 A	26.8 A	53.5 A	3 A	2 A	—	0.5 A	0.5 A	25.2 to 30.8
30 V	S	6.5 A	11 A	25 A	50 A	—	—	—	—	—	27.0 to 33.0
33 V	T	6.2 A	10.9 A	22.7 A	35.8 A	—	—	—	—	—	29.7 to 36.3
36 V	U	5.8 A	10 A	20.8 A	35.8 A	—	—	—	—	—	32.4 to 39.6
42 V	V	4.2 A	7.5 A	16 A	35.7 A	—	—	—	—	—	37.8 to 46.2
48 V	W	4 A	7.5 A	15.6 A	31.2 A	—	—	—	—	—	43.2 to 52.8
54 V	X	3.7 A	6 A	13.9 A	27.7 A	—	—	—	—	—	48.6 to 59.4
60 V	Y	3.5 A	6 A	12.5 A	25 A	—	—	—	—	—	54.0 to 66.0
Consult Factory											
Special	Z	35 A	60 A	150 A	—	—	10 A	—	—	—	2.3 to 2.6
Special	Z	35 A	60 A	150 A	—	—	10 A	—	—	—	3.7 to 4.4
Special	Z	20 A	36 A	80 A	140 A	—	8 A	—	—	—	6.7 to 7.1

### Parallel Codes

0 = No parallel  
 1 = 1 & 2  
 2 = 2 & 3  
 3 = 3 & 4  
 4 = 4 & 5  
 5 = 3 & 4 & 5  
 6 = 5 & 6  
 7 = 4 & 5 & 6  
 8 = 6 & 7  
 9 = 3 & 4, 6 & 7  
 A = 1 & 2, 3 & 4, 5 & 6  
 C = 2 & 3, 4 & 5  
 E = 4 & 5, 5 & 6

Increments of current Not shown can be achieved by paralleling modules (add currents of each module selected).

1 Programmable  
 2 Contact factory for extended range down to 6 V  
 3 Total output power on dual module must Not exceed 144 W.  
 4 For single output modules only.  
 5 Applicable for iMP1 only.

ORDERING INFORMATION

Sample below is 1500 W case with 12 V @ 62.5 A; 5 V @ 60 A; 24 V @ 8.5 A; 12 V @ 10 A; 12 V @ 4 A; with No options.

Case Size	Module/Voltage/Option Codes First - Module Code Second - Voltage Code Third - Option Code	Case Option Codes	Software Code	Hardware Code
<b>iMP1<sup>1</sup></b>	<b>3L0 - 2E2 - 1Q1 - 4LL0</b>	<b>00</b>	<b>A</b>	<b>###</b>
<p><b>Case Size (mm)</b>                      4 = 2.5" x 5" x 10"; 750 to 1100 W, 5 slots                      (63.5 x 127 x 254)                      8 = 2.5" x 7" x 10"; 1000 to 1200 W, 6 slots                      (63.5 x 177.8 x 254)                      1 = 2.5" x 8" x 11"; 1200 to 1500 W, 7 slots                      (63.5 x 203.2 x 279.4)</p> <p>1: Add "E" after iMP4 to denote IEC input option. e.g., iMP4E                      (Not available on iMP8 or iMP1)</p>	<p><b>Module Codes</b>                      Module/voltage/option codes                      Module codes:                      (None) = 36 W triple O/P (1 slot)                      1 = 210 W single O/P (1 slot)                      2 = 360 W single O/P (2 slot)                      3 = 750 W single O/P (3 slot)                      4 = 144 W dual O/P (1 slot)                      5 = 1500 W single O/P (4 slot)                      6 - 9 = Future</p> <p><b>Voltage Codes</b>                      See Output Module Voltage/Current table above</p> <p><b>Option Codes</b>                      0 = Standard                      1 = Module enable                      2 = Constant current                      3 = 1 &amp; 2 combined                      4 = Set for use in standard (Non-intelligent case)                      5 = Shutdown mode for 1500 W                      6 = 1 &amp; 5 combined                      7 - 9 = Future</p>	<p><b>Case Option Codes</b></p> <p>First digit                      0 - 9 = parallel code                      (See Parallel Codes table above)</p> <p>Second digit                      0 = No options                      1 = Reverse air                      3 = Global enable                      4 = Fan idle w/inhibit                      5 = Opt 1 + Opt 3                      6 = Opt 1 + Opt 4                      7 = Opt 3 + Opt 4                      8 = Opt 1 +3 +4                      9 = RS-485 73-544-002                      C = 9 + 3                      D = CANBUS 73-544-003                      E = D + 3</p>	<p>Software code used for configuration change. "A" is standard</p>	<p>Factory assembled for hardware of firmware mods.</p>
<p><b>Ordering Note:</b>                      1. USB to I<sup>2</sup>C module order code 73-769-001 or -002</p>				



## MicroMP Series

Cost-efficient, Configurable Power Supply with Market-leading Density and Efficiency  
Up to 1800 Watts with New Product Enhancements

### SPECIAL FEATURES

- Optional conformal coating
- Industrial temp range (-40 to 70°C)
- Industrial shock/vibration (> 50 G's)
- Low cost
- Standard medical leakage (< 400  $\mu$ A) with optional low leakage (< 100  $\mu$ A)
- New 1000 W modules
- PMBus™
- High efficiency
- Low profile 1U size
- Multi output
- Current limit - constant current foldback (optional)
- Low acoustic noise
- High power density
  - uMP04: 10.8 W/in<sup>3</sup>
  - uMP09: 18.0 W/in<sup>3</sup>
  - uMP10: 15.1 W/in<sup>3</sup>
  - uMP16: 22.9 W/in<sup>3</sup>
- Intelligent fan (speed control/fault status)
- Downloadable GUI from website
- $\mu$ P controlled PFC input with active inrush protection
- No preload required
- IEC, terminal block, or barrier strip input option

### Total Power

Up to 1800 Watts

### Input Voltage

- 85 to 264 VAC
- 120 to 300 VDC

### # of Outputs

Up to 12

### Safety

- UL UL60950/UL60601-1
- CSA CSA22.2 No. 234 Level 5
- VDE EN60950/EN60601-1
- BABT Compliance to EN60950/EN60601 BS7002
- CB Certificate and report
- CE Mark to LVD
- CCC Approved

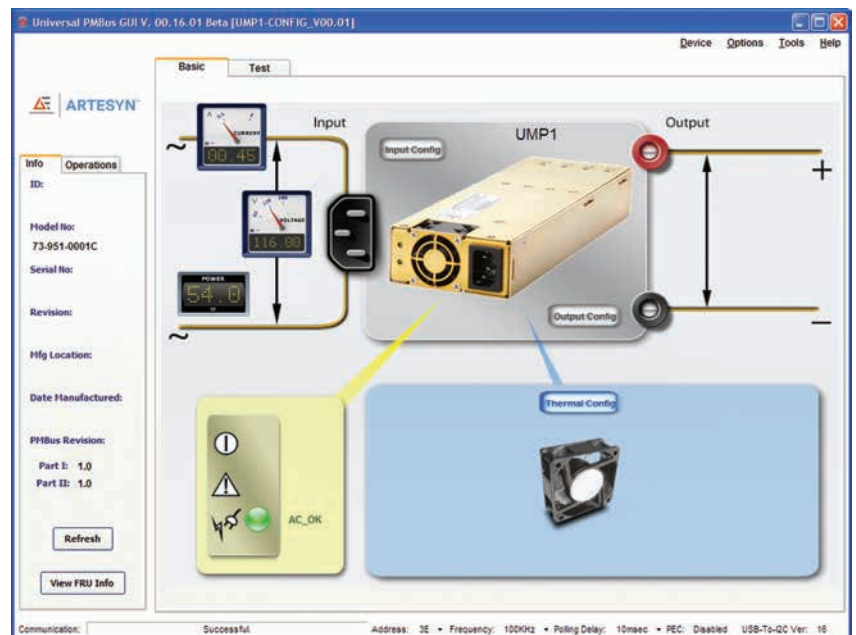



Electrical Specifications	
<b>Input</b>	
Input Range	85 to 264 VAC 120 to 350 VDC (limited to 300 VDC in medical apps)
Frequency	47 to 440 Hz
Inrush Current	40 A peak max (soft start)
Efficiency	Up to 91% @ full case load
Power Factor	0.99 typ meets EN61000-3-2 (n/a @ 440 Hz)
Turn-on Time	AC on 2 sec for $\mu$ MP10/16 and 1.5 sec for $\mu$ MP04, inhibit/enable 250 ms typical
EMI Filter	CISPR 22/EN55022 Level "B"
Leakage Current	< 200 $\mu$ A using center-tapped xfmr measurement method. (< 400 $\mu$ A @ 264 VAC input)
Radiated EMI	CISPR 22/EN55022 Level "B"
Warranty	Two years
<b>Output</b>	
Factory Set Point Accuracy	$\pm$ 1%
Margining or Optional V Program	$\pm$ 3-7% Nominal analog (single output module only)
Overall Regulation	0.4% or 30 mV which ever is greater
Ripple	RMS: 0.1% or 10 mV, whichever is greater Pk-Pk: 1.0% or 50 mV, whichever is greater Bandwidth limited to 20 MHz
Dynamic Response	< $\pm$ 5% or 250 mV, with 50% step load
Recovery Time	To within 1% in < 300 $\mu$ s
Reverse Voltage Protection	100% of rated output current
Thermal Protection (OTP)	All outputs disabled when internal temp exceeds safe operating range.
Remote Sense	Up to 0.5 V total drop (Not available on triple output module)
Single Wire Parallel	Current share to within 5% of total rated current
DC OK	$\pm$ 5% of Nominal
Minimum Load	Not required; signal is open collector
Housekeeping Standby	5 VDC @ 2.0 A max present whenever AC input is applied
Module Inhibit	Logic - output on with low or open. Different logic options available
Output/Output Isolation	> 1 Megohm, 500 V

Environmental Specifications	
Operating Temperature	-40 to 70°C ambient. Derate each output 2.5% per degree from 50 to 70°C. (-20°C start-up) Meets full spec after 1/2 load. 10 min warm-up
Storage Temp	-40 to 85°C
Electromagnetic Susceptibility	Designed to meet EN61000-4; -3, -6, -11 Level 3, Level 4 for -2, -4, -5
Humidity	Operating; Non-condensing 10 to 95% RH
Vibration	MIL-STD-810E
MTBF Demonstrated	> 350,000 hours at full load, one $\mu$ MP04 case + two modules, Telcordia SR-332 calculated MTBF
Altitude:	Up to 10k ft; derate linear to 50% from 10 to 30k ft

**ORDERING INFORMATION**

Case Size	Module/Voltage	Case Option Codes	Software Code	Hardware Code
<b><math>\mu</math>MPXY</b>	<b>SKW - S2E - S2Q - ILL</b>	<b>00</b>	<b>A</b>	<b>###</b>
1-Phase Input where X = 04= 1.57" x 3.5" x 10.0"; 400 W to 600 W, 4 Slots 09= 1.57" x 3.5" x 10.0"; 550 W to 1100 W, 4 Slots 10= 1.57" x 5.0" x 10.0"; 1000 W to 1200 W, 6 Slots 16= 1.57" x 5.0" x 10.0"; 1200 W to 1800 W, 6 Slots 1: See Input Derating table below for $\mu$ MP16 Input Type where Y = T = Terminal Block C = IEC Connector C14 S = Barrier Strip	<b>Module Codes</b> S2 = 200 W Single O/P (1 Slot) SK = 1000 W Single O/P (3 Slot) I = 96 W Dual O/P ISO GND (1 Slot) <b>Voltage Codes:</b> See Voltage Code Table	<b>Case Option Codes</b> First digit 0 - K = Parallel Code Second digit 0 = No Options 1 = Reverse Air 2 = Not Used 3 = Global Enable 5 = Opt 1 + Opt 3	Factory assigned for modified standards	Factory assigned for modified standards



# CoolX® 1800

## High Efficiency, Intelligent and Reliable 1800 W Modular Power Supplies

### SPECIAL FEATURES

#### Modular Power Supply

- Up to 1800 W
- Up to 12 outputs
- All outputs isolated (1850 VAC)
- Variable fan speed control

#### Reliability

- MTBF > 200,000 hours
- Level 4 input surge protection
- 23.5 W always ON auxiliary power output
- Safety approved to 5000 m altitude
- 91% efficiency
- Five-year warranty

#### Flexibility

- Analog and digital management — PMBus™ monitoring and control capability
- Field-configurable — plug and play power
- Series and parallel outputs for higher voltages and currents
- Mounting options — base/side and DIN-Rail mounting

### Total Power

- CX18S 1800 W
- CX18M 1800 W

### Slots

6, 6

### Cooling

Variable fan speed control

### Parameters

10.5" x 5" x 1U

### Safety

#### Medical (CX18M)

- IEC60601-1 3rd edition, IEC60601-1-2 4th edition (EMC)
- 2 MOPP
- Dual fused
- ISO13485

#### Industrial (CX18S)

- IEC60950, IEC62368-1
- SEMI F47<sup>1</sup>

#### Defense/Aero (All Models)

- MIL-STD-810G

<sup>1</sup> SEMI F47 compliant at input voltages > 180 VAC. Consult Advanced Energy for details.

### TYPICAL APPLICATIONS

#### Medical

- Clinical diagnostic equipment, medical lasers, dialysis equipment, radiological imaging, chemical chemistry

#### Industrial

- Test and measurement, industrial machines, automation equipment, printing, telecommunications, MIL-COTS

#### Audio Equipment

- Hi rel, harsh industrial electronics, radar (marine- and ground-based), communications, test and measurement

## Ordering Information

Ordering Information					
Single Output Modules (1 Slot)		Vnom (V)	Set Point Adjust Range (V)	I <sub>max</sub> (A)	Power (W)
CmA		5	2.5 to 6.0	30.0	150
CmB <sup>1</sup>		12	6.0 to 15.0 <sup>2</sup>	23.3	280
CmC		24	15.0 to 28.0	12.5	300
CmD		48	28.0 to 58.0 <sup>3</sup>	6.25	300
High Power Modules (3 Slot)					
CmE <sup>4</sup>		24	24 to 25.2	37.5	900
CmF <sup>4</sup>		48	48 to 50.4	18.75	900
Dual Output Modules (1 Slot)					
CmG <sup>5</sup>	V1	24	3.0 to 30.0	4.0	120
	V2	24	3.0 to 30.0	4.0	120
CmH <sup>6</sup>	V1	5	3.0 to 6.0	10.0	60
	V2	24	3.0 to 30.0	4.0	120
Wide Trim Modules (1 Slot)					
CmA-W01		5	1.0 to 6.0	30	150
CmB-W01		12	1.0 to 15.0 <sup>2</sup>	23.3	280
CmC-W01		24	2.0 to 28.0	12.5	300
CmD-W01		48	3.0 to 58.0 <sup>3</sup>	6.25	300

## Environmental Specifications

Parameter	Conditions/Description	Min	NOM	Max	Units
Operating Temperature	Operates to specification below -20°C after 10 min warm-up	-40	—	70	°C
Storage Temperature		-40	—	85	°C
Derating	See derating curves	—	—	—	—
Relative Humidity	Non-condensing	5	—	95	% RH
Shock and Vibration	MIL-STD-810G Method 514.6	—	—	—	—
Altitude		—	—	5000	m

<sup>1</sup> Full dynamic specifications may Not be met at full load when output voltage is trimmed above 13 V.

<sup>2</sup> Max Trim 14 V when used with High Power Module

<sup>3</sup> Max Trim 56 V when used with High Power Module

<sup>4</sup> a) Only one High Power module (CmE or CmF) can be used per CoolPac.

b) During load transients starting from 0% load on the High Power modules, other modules in the CoolPac may experience an output voltage dynamic during the load change. Contact applications support for details or support..

<sup>5</sup> For the CmG module the max combined power of both outputs is 200 W.

<sup>6</sup> For the CmH module the max combined power of both outputs is 180 W.



# CoolIX® 3000

High Efficiency, Intelligent, and Reliable 3000 W Modular Power Supply

## SPECIAL FEATURES

### Modular Power Supply

- Up to 3000 W
- Up to 24 outputs
- All outputs isolated (1850 VAC)
- Variable fan speed control

### Reliability

- MTBF > 150,000 hours
- Level 4 input surge protection
- 23.5 W always ON auxiliary power output
- Safety approved to 5000 m altitude
- 91% efficiency
- Five-year warranty

### Flexibility

- Analog and digital management — PMBus™ monitoring and control capability
- Field-configurable — plug and play power
- Series and parallel outputs for higher voltages and currents
- Mounting options — base/side

## Total Power

- CX30S 3000 W
- CX30M 3000 W

## Slots

12, 12

## Cooling

Variable fan speed control

## Parameters

11.8" x 5.2" x 4.7"

## Safety

### Medical (CX30M)

- IEC60601-1 3rd edition, IEC60601-1-2 4th edition (EMC)
- 2 MOPP
- Dual fused

### Industrial (CX30S)

- IEC62368-1

## TYPICAL APPLICATIONS

### Medical

- Clinical diagnostic equipment, medical lasers, dialysis equipment, radiological imaging, chemical chemistry

### Hi Rel

- Harsh industrial electronics, radar (marine- and ground-based), communications, test and measurement

### Industrial

- Test and measurement, industrial machines, automation equipment, printing, telecommunications

Ordering Information					
Single Output Modules (1 Slot)		Vnom (V)	Set Point Adjust Range (V)	I <sub>max</sub> (A)	Power (W)
CmA		5	2.5 to 6.0	30.0	150
CmB <sup>1</sup>		12	6.0 to 15.0 <sup>2</sup>	23.3	280
CmC		24	15.0 to 28.0	12.5	300
CmD		48	28.0 to 58.0 <sup>3</sup>	6.25	300
High Power Modules (3 Slot)					
CmE <sup>4</sup>		24	24 to 25.2	37.5	900
CmF <sup>4</sup>		48	48 to 50.4	18.75	900
Dual Output Modules (1 Slot)					
CmG <sup>5</sup>	V1	24	3.0 to 30.0	4.0	120
	V2	24	3.0 to 30.0	4.0	120
CmH <sup>6</sup>	V1	5	3.0 to 6.0	10.0	60
	V2	24	3.0 to 30.0	4.0	120
Wide Trim Modules (1 Slot)					
CmA-W01		5	1.0 to 6.0	30	150
CmB-W01		12	1.0 to 15.0 <sup>2</sup>	23.3	280
CmC-W01		24	2.0 to 28.0	12.5	300
CmD-W01		48	3.0 to 58.0 <sup>3</sup>	6.25	300

Environmental Specifications					
Parameter	Conditions/Description	Min	NOM	Max	Units
Operating Temperature		-25	—	60	°C
Storage Temperature		-25	—	85	°C
Derating	CX30: Derate from 50°C	—	50	60	°C
Relative Humidity	Non-condensing	5	—	95	% RH
Shock		—	—	40	G
Altitude		—	—	5000	m

- <sup>1</sup> Full dynamic specifications may Not be met at full load when output voltage is trimmed above 13 V.
- <sup>2</sup> Max Trim 14 V when used with High Power Module
- <sup>3</sup> Max Trim 56 V when used with High Power Module
- <sup>4</sup> a) Only one High Power module (CmE or CmF) can be used per CoolPac.  
b) During load transients starting from 0% load on the High Power modules, other modules in the CoolPac may experience an output voltage dynamic during the load change. Contact applications support for details or support..
- <sup>5</sup> For the CmG module the max combined power of both outputs is 200 W.
- <sup>6</sup> For the CmH module the max combined power of both outputs is 180 W.



# Intelligent VS Series

Intelligent Modular Power Supply for Optimum Flexibility  
Up to 4920 Watts

## SPECIAL FEATURES

### Medical EN60601-1 approval

- Intelligent I<sup>2</sup>C control
- Voltage adjustment on all outputs (manual or I<sup>2</sup>C)
- Configurable input and output OK signals and indicators
- Configurable inhibit/enable
- Configurable output UP/DOWN sequencing
- High power density (12 W/in<sup>3</sup>)
- Intelligent fan (speed control/fault status)
- $\mu$ P controlled PFC input with active Inrush protection
- I<sup>2</sup>C monitor of voltage, current and temp
- Programmable voltage, current limit, inhibit/enable through I<sup>2</sup>C
- CAN BUS and RS-485 interface option
- Optional extended hold-up module (SEMI F47 compliance)
- Increased power density to 150%
- Optional conformal coating
- Industrial temp range (-40 to 70°C)
- Uses standard iMP modules
- Field upgradeable firmware
- RoHS compliant

### Total Power

Up to 4920 Watts

### Input Voltage

- 85 to 264 VAC
- 120 to 300 VDC

### # of Outputs

Up to 24

### Safety

- UL UL60950/UL2601
- CSA CSA22.2 No. 234 Level 5
- VDE EN60950/EN60601-1
- BABT Compliance to EN60950/EN60601 BS7002
- CB Certificate and report
- CE Mark to LVD

### Single

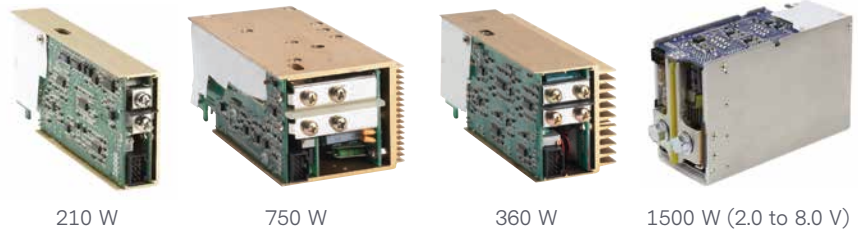

### Dual

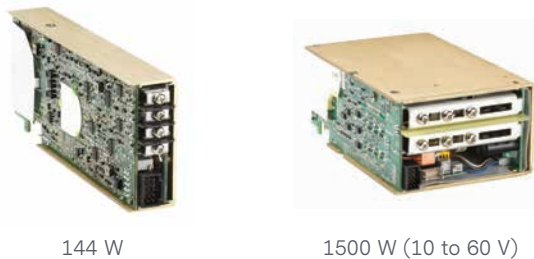

### Triple



Electrical Specifications	
<b>Input</b>	
Input Range	
iVS1 & iVS3:	90 to 264 VAC 1Ø: 120 to 300 VDC
iVS6 & iVS8:	170 to 264 VAC 3Ø
iVS8H <sup>1</sup> :	380/480 VAC 3Ø
Frequency	47 to 63 Hz
Inrush Current	40 A peak maximum (soft start)
Efficiency	Up to 85% @ full case load
Power Factor	0.99 typ meets EN61000-3-2
Turn-on Time	AC on 1.5 sec typical, inhibit/enable 150 ms typical. Programmable
EMI Filter	CISPR 22/EN55022 Level "B"
Leakage Current	300 µA max @ 240 VAC; 47 to 63 Hz
Radiated EMI	CISPR 22/EN55022 Level "B"
Holdover Storage	10 ms minimum (independent of input VAC) additional 20 ms holdover storage with optional HUP module (SEMI F47 compatible)
AC OK	> 5 ms early warning minutes before outputs lose regulation. Full cycle ride thru (50 Hz). Programmable
Harmonic Distortion	Meets EN61000-3-2
Isolation	Meets EN60950 and EN60601 Meets 1 MOPP Primary to ground, 2 MOPP Primary to Secondary <sup>1</sup>
Global Inhibit/Enable	TTL, Logic "1" and Logic "0"/configurable
Warranty	Three years
<b>Output</b>	
Adjustment Range <sup>2</sup>	±10% minimum all outputs (manual) (full module adjustment range using I <sup>2</sup> C)
Margining	±4 to 6% Nominal analog (single output module only)
Overall Regulation	0.4% or 20 mV max (1500 W modules 1% max)
Ripple	RMS: 0.1% or 10 mV, whichever is greater Pk-Pk: 1.0% or 50 mV, whichever is greater Bandwidth limited to 20 MHz
Dynamic Response	< 2% or 100 mV, with 25% load step
Recovery Time	To within 1% in < 300 µs
Over-current Protection <sup>3</sup>	Configurable through I <sup>2</sup> C. single output module and main output of the dual output module 105 to 120% of rated output current. Aux output of dual output module 105 to 140% of rated output current. Special programmable OCP delay on 1500 W module from 100 ms to 25.5 seconds with shutdown features
Short-circuit Protection	Protected for continuous short-circuit. Recovery is automatic upon removal of short (Shutdown mode on 1500 W module)
Over-voltage Protection <sup>2</sup>	Configurable through I <sup>2</sup> C
– Single Output Module	2 to 5.5 V 122 to 134%; 6 to 60 V 110 to 120%
– Dual Output Module	2 to 6 V 122 to 134%; 8 to 28 V 110 to 120%
– Triple Output Module	No over-voltage protection provided
Thermal Protection <sup>2</sup>	Configurable through I <sup>2</sup> C All outputs disabled when internal temp exceeds safe operating range. > 5 ms warning (AC OK signal) before shutdown
Remote Sense	Up to 0.5 V total drop (Not available on triple output module)
Single Wire Parallel	Current share to within 2% of total rated current
DC OK <sup>2</sup>	±5% of Nominal. Configurable through I <sup>2</sup> C
Minimum Load	Not required
Housekeeping Bias Voltage	5 VDC @ 1.0 A max present whenever AC input is applied
Module Inhibit <sup>2</sup>	Configured and controlled through I <sup>2</sup> C
Output/Output Isolation	> 1 Megohm, 500 V

<sup>1</sup> iVS8H does Not have Medical or MOPP approvals

<sup>2</sup> Can be controlled via I<sup>2</sup>C

<sup>3</sup> Controlled via I<sup>2</sup>C but requires load calibration

## INTELLIGENT HIGH POWER

Environmental Specifications	
Operating Temperature	-40 to 70°C ambient. Derate each output 2.5% per degree from 50 to 70°C. (-20°C start-up)
Storage Temperature	-40 to 85°C
Electromagnetic Susceptibility	Designed to meet EN61000-4; -2, -3, -4, -5, -6, -8, -11 Level 3
Humidity	Operating; Non-condensing 10 to 95% RH
Vibration	IEC68-2-6 to the levels of IEC721-3-2
MTBF Demonstrated	> 550,000 hours at full load, 220 VAC and 25°C ambient conditions

Output Module Line-up							
Module Code	1	2	3	5	4		
Module Type	Single	Single	Single	Single	Dual		Triple
Max Output Power	210 W	360 W	750 W	1500 W	144 W		36 W
Max Output Current	35 A	60 A	150 A	300 A	10 A		2 A
Output Voltages Available <sup>1</sup>	2 to 60 V	2 to 60 V	2 to 60 V	2 to 60 V	6 to 15, 24 to 28; 6 to 15; 6 to 15; 6 to 15; 2 to 6; 2 to 6; 2 to 6, 2 to 6; 24 to 28, 24 to 28; 24 to 28; 2 to 6		8 to 15, 8 to 15, 2 to 6; 8 to 15, 8 to 15, 8 to 15; 8 to 15, 8 to 5, 18 to 28; 8 to 15, 18 to 28, 2 to 6
Standard Voltage Increments	25	25	25	18	16		18
Remote Sense	Yes	Yes	Yes	Yes	Yes	Yes	No
Remote Margin <sup>1</sup>	Yes	Yes	Yes	Yes	No	No	No
V-Program - I <sup>2</sup> C Control <sup>1</sup>	Yes	Yes	Yes	Yes	Yes	Yes	No
Active Current Share	Yes	Yes	Yes	Yes	Yes	No	No
Module Inhibit - I <sup>2</sup> C Control <sup>1</sup>	Yes	Yes	Yes	Yes	Yes	Yes	Yes
Module Inhibit - Analog	Yes	Yes	Yes	Yes	No	No	No
Over-voltage/Over-current Protection <sup>1</sup>	Yes	Yes	Yes	Yes	Yes	Yes	Yes
Minimum Load Required	No	No	No	No	No	No	No
Slots Occupied in any iMP Case	1	2	3	4	1		1

<sup>1</sup> Programmables



Output Module Voltage/Current											
Voltage	Voltage Code	Single Output Module Code				Dual Output <sup>2</sup>		Triple Output			I <sup>2</sup> C Adjustment Ranges <sup>3</sup>
		1	2	3	5	V1	V2				
2 V	A	35 A	60 A	150 A	300 A	10 A	10 A	—	—	2 A	1.8 to 2.2
2.2 V	B	35 A	60 A	150 A	300 A	10 A	10 A	—	—	2 A	2.0 to 2.4
3 V	C	35 A	60 A	150 A	300 A	10 A	10 A	—	—	2 A	2.7 to 3.3
3.3 V	D	35 A	60 A	150 A	300 A	10 A	10 A	—	—	2 A	3.0 to 3.6
5 V	E	35 A	60 A	150 A	300 A	10 A	10 A	—	—	2 A	4.5 to 5.5
5.2 V	F	35 A	60 A	144 A	288 A	10 A	10 A	—	—	2 A	4.7 to 5.7
5.5 V	G	34 A	58 A	136 A	273 A	10 A	10 A	—	—	2 A	5.0 to 6.1
6 V	H	23 A	42 A	97.5 A	250 A	10 A <sup>1</sup>	10 A <sup>1</sup>	—	—	2 A	5.4 to 6.6
8 V	I	20 A	36 A	84.4 A	140 A	10 A	4 A	1 A	1 A	1 A	7.2 to 8.8
10 V	J	18 A	32 A	75 A	140 A	10 A	4 A	1 A	1 A	1 A	9.0 to 11.0
11 V	K	17 A	31 A	68 A	136.3 A	10 A	4 A	1 A	1 A	1 A	9.9 to 12.1
12 V	L	17 A	30 A	62.5 A	125 A	10 A	4 A	1 A	1 A	1 A	10.8 to 13.2
14 V	M	14 A	21 A	53.5 A	107 A	9 A	4 A	1 A	1 A	1 A	12.6 to 15.4
15 V	N	14 A	20 A	50 A	100 A	8 A	4 A	1 A	1 A	1 A	13.5 to 16.5
18 V	O	11 A	19 A	41.6 A	83.3 A	—	—	—	0.5 A	0.5 A	16.2 to 19.8
20 V	P	10.5 A	18 A	37.5 A	75 A	—	—	—	0.5 A	0.5 A	18.0 to 22.0
24 V	Q	8.5 A	15 A	30 A	62.5 A	4 A	2 A	—	0.5 A	0.5 A	21.6 to 26.4
28 V	R	6.7 A	11 A	26.8 A	53.5 A	3 A	2 A	—	0.5 A	0.5 A	25.2 to 30.8
30 V	S	6.5 A	11 A	25 A	50 A	—	—	—	—	—	27.0 to 33.0
33 V	T	6.2 A	10.9 A	22.7 A	35.8 A	—	—	—	—	—	29.7 to 36.3
36 V	U	5.8 A	10 A	20.8 A	35.8 A	—	—	—	—	—	32.4 to 39.6
42 V	V	4.2 A	7.5 A	16 A	35.7 A	—	—	—	—	—	37.8 to 46.2
48 V	W	4 A	7.5 A	15.6 A	31.2 A	—	—	—	—	—	43.2 to 52.8
54 V	X	3.7 A	6 A	13.9 A	27.7 A	—	—	—	—	—	48.6 to 59.4
60 V	Y	3.5 A	6 A	12.5 A	25 A	—	—	—	—	—	54.0 to 66.0
Consult Factory											
Special	Z	35 A	60 A	150 A	—	—	10 A	—	—	—	2.3 to 2.6
Special	Z	35 A	60 A	150 A	—	—	10 A	—	—	—	3.7 to 4.4
Special	Z	20 A	36 A	80 A	140 A	—	8 A	—	—	—	6.7 to 7.1

1 Consult factory for extended range down to 6 V.  
 2 Total output power on dual model must not exceed 144 W.  
 3 For single output modules only.

**ORDERING INFORMATION**

Sample below is 3210 W case with 12 V @ 125 A; 24 V @ 8.5 A; 5 V @ 60 A; 12 V @ 10 A and 12 V @ 4 A; with no options.

Case Size	Module/Voltage/Option Codes First - Module Code Second - Voltage Code Third - Option Code	Case Option Codes	Software Code	Hardware Code
<b>iVS1</b>	<b>5L1 - 1Q1 - 2EO - 4LL0</b>	<b>00</b>	<b>A</b>	<b>###</b>
<p><b>Case Size (mm)</b>  <b>1-Phase Input</b>                      1 = 5" x 5" x 11"; 1500 to 3210 W, 9 slots (127 x 127 x 279.4)                      3 = 5" x 8" x 11"; 1800 to 4920 W, 14 slots (127 x 203.2 x 279.4)  <b>3-Phase Input</b>                      6 = 5" x 5" x 11"; 3120 W, 9 slots (127 x 127 x 279.4)                      8 = 5" x 8" x 11"; 4920 W, 14 slots (127 x 203.2 x 279.4)                      8H<sup>1</sup> = 5" x 8" x 11"; 4920 W, 14 slots (127 x 203.2 x 279.4)                      1: The input is 380 to 440 VAC 3 phase Nominal, 3-phase versions Not medically approved.</p>	<p><b>Module Codes</b>                      Module/voltage/option codes                      Module Codes:                      (None) = 36 W triple O/P (1 slot)                      1 = 210 W single O/P (1 slot)                      2 = 360 W single O/P (2 slot)                      3 = 750 W single O/P (3 slot)                      5 = 1500 W single O/P (slot 4)                      4 = 144 W dual O/P (1 slot)                      HUP = Extra 30mS hold-up (1 slot)  <b>Voltage Codes:</b>                      See Output Module Voltage/                      Current table above  <b>Option Codes:</b>                      0 = Standard                      1 = Module enable                      2 = Constant current                      3 = 1 &amp; 2 combined                      4 = Set for use in standard (Non-intelligent case)                      5 = Shutdown mode for 1500 W                      6 = 1 &amp; 5 combined                      7-9 = Future</p>	<p><b>Case Option Codes</b>                      First Digit                      0-9 = Parallel code (See parallel codes table in datasheet)                      Second Digit                      0 = No options                      1 = Reverse air                      2 = Not used                      3 = Global enable                      4 = Fan idle w/inhibit                      5 = Opt 1 + Opt 3                      6 = Opt 1 + Opt 4                      7 = Opt 3 + Opt 4                      8 = Opt 1 + 3 + 4                      9 = RS485 73-544-001                      B = USB 73-546-001                      C = 9 + 3                      D = CANBus 73-544-004                      E = D + 3</p>	<p>Software code used for configuration change. "A" is standard</p>	<p>Factory assembled for hardware of firmware mods.</p>
<p><b>Ordering Note:</b>                      1. USB to I<sup>2</sup>C module order code 73-769-001</p>				



# Precision High Power System

Up to 24000 Watts

## SPECIAL FEATURES

- Multi output precision high power system
- Standard 19" rack
- Outputs parallel up to 1600 A
- Outputs series up to 1000 V
- 100% digital control
- Outputs program as voltage or current source
- Versatile input configurable to:
  - Low Line 180 to 264 VAC Single/3-Phase
  - High Line 342 to 528 VAC 3-Phase
- Medical safety approved – No ISOLATION XFMR NEEDED
- Flexible control interfaces: Analog 0 to 5 V or 0 to 10 V; Digital Ethernet UDP, RS485, CAN, etc. or Ethernet TC/IP with PowerPro Connect Module option. Command protocol standard PMBus.
- Air cooled
- Semi F47 compliance
- Field upgradeable firmware
- Programmable slew rate
- Fast current slew rate up to 200 Hz
- Active power factor correction
- User defined command profiles
- Direct drive current source for large scale LED grow luminaries

### Total Power

Up to 24 KW

### Input Voltage

- 180 to 264 VAC
- 342 to 528 VAC
- 600 VAC for Canadian Version
- 3-Phase
- 1-Phase available on 12KW Modules

### # of Outputs

Up to 8

### Safety

- UL 60950-1 2<sup>nd</sup> Edition; EN60950-1; IEC60950-1/EN60950
- CSA C22.2 No. 60950-1-07, 2<sup>nd</sup> Edition
- EN60601-1; IEC60601-1; IEC60601
- UL 60601-1 1st Edition; ANSI/AAMI ES60601-1 (2005 + C1:09 + A2:10) "3<sup>rd</sup> Ed"
- CAN/CSA-C22.2 No. 60601-1 (2008)
- UL/CSA 61010 and IEC/EN 61010-1
- CB Certificate and Report
- CE (LVD+RoHS), EN60950-1

### Electrical Specifications

Input Parameter	19" Rack 24 KW strapped as 3-Phase 380/480 VAC Nominal (iHP24H3A/L)	19" Rack 24 KW strapped as 3-Phase 208/240 VAC Nominal (iHP24L3A/L)
Input Range	342 VAC to 528 VAC (Nominal rating 380/480 VAC)	187.5 VAC to 264 VAC (Nominal rating 208/240 VAC)
Number of Phases	3-phase (Wye or Delta) 4 wire total (3-phase and 1 protective earth ground)	
Frequency	47 to 440 Hz	
Phase Detection	Loss of phase will inhibit unit off. Housekeeping/comms must continue with phase loss.	
Max Current/Phase	51 A @ 380 VAC 40 A @ 480 VAC	84 A @ 208 VAC
Under-voltage Detection	Nominal input locked on at turn-on. Under-voltage shutdown @ 15% below Nominal. Turn-on @ 12% below Nominal. Not to interfere with SEMI F47 specs.	
Current Inrush	2.5 x max input current	
Power Factor	> 0.9 @ full load and Nominal line	> 0.98 @ full load and Nominal line
Harmonic Distortion	THD < 13%, PWHD < 22% (refer to EN 61000-3-12)	
Line Interruption	Designed to meet SEMI F47-0706, 53, 58, S14 @ Nominal input voltages	
Input Leakage Current	< 2.5 mA Note for fixed condition 3rd edition leakage = 5 mA	
POWER Switch	Front panel power switch required	
Input Protection	Internal fuse (Not user serviceable)	
Input Over-voltage Protection	Up to 115% of Nominal input shall Not damage unit	
Phase Imbalance	≤ 5%	
Rack Parallel	Up to 6 racks (144 KW)	

## Output – General Specifications

Parameter								
Module Code	SL	SQ	ST	SW	S8	S1	SA	S2
# Outputs	1	1	1	1	1	1	1	1
Nominal O/P (V)	12.0 V	24.0 V	32.0 V	48.0 V	80.0 V	125.0 V	200.0 V	250.0 V
Max Power (W)	2400 W	2880 W	2880 W	3000 W	3000 W	3000 W	3000 W	3000 W
O/P Current Range (A)	0.0 A to 200 A	0.0 A to 120 A	0.0 A to 90 A	0.0 A to 62.5 A	0.0 A to 37.5 A	0.0 A to 24 A	0.0 A to 15 A	0.0 A to 12 A
Power Density (W/in <sup>3</sup> )	32.5	39.0	39.0	40.6	40.6	40.6	39.0	40.6
Efficiency (%)	93.5	93.5	93.5	93.5	93.5	93.5	93.5	93.5
Module Input Voltage	400 VDC							
Module Operating Temp	-0 to +65°C; Baseplate Temp TBD							
Series Operation	250 V modules can be connected in series up to 800 V for Medical and 1000 V above ground with No operation ON/OFF limitations							
Parallel Operation	Up to 8 modules can be paralleled in 1 rack, with up to 6 racks connected in parallel. Single Wire Parallel connection will be provided as part of configuration							

## PRECISION HIGH POWER

Output – Module In Constant Voltage Mode								
Constant Voltage								
Module Code	SL	SQ	ST	SW	S8	S1	SA	S2
Nominal Output (V)	12	24	32	48	80	125	200	250
Setting Range (V)	0.6 to 14.4 V	1.2 to 28.8 V	1.6 to 38.4 V	2.4 to 57.6 V	4.0 to 96.0 V	6.25 to 150.0 V	10.0 to 240.0 V	12.5 to 300.0 V
Low Frequency RMS Ripple (mV)	24	48	64	96	160	250	400	500
Line Regulation (mV)	12	24	32	48	80	125	200	250
Load Regulation (mV)	24	48	64	96	160	250	400	500
P-P Ripple (mV)	60	120	100	240	400	625	1250	1250
Drift (Temp Stability)	±0.05% of I <sub>out</sub> Rated over 8 hours, after 30 min warm-up, constant Line, Load and Temp							
Temp Coefficient (PPM/°C)	200							
Pgm Accuracy (mV)	Digital: 0.1% of Nominal Output Voltage; Analog: 1.0% of Nominal Output Voltage							
Pgm Resolution (mV)	SL=TBD; SQ=1; SW=2; S8=8; S1=6; S2=21							
Meas Accuracy (mV)	0.2% + 0.2% of Nominal Output Voltage							
Meas Resolution	SL=TBD; SQ=1; SW=2; S8=8; S1=6; S2=21							
Transient Response	Max 5.0% deviation from current set point must recover within 1mS for a 50% step load.							
Current Sense Method	Internal Shunt; External Shunt can be used for higher resolution and accuracy							

Output – Module In Constant Current Mode								
Constant Voltage - Programmable load compensation available for resistive and inductive loads; capacitive load applications; and LED drive applications								
Module Code	SL	SQ	ST	SW	S8	S1	SA	S2
Nominal Output (V)	12	24	32	48	80	125	200	250
Setting Range (A)	0.0 to 200 A	0.0 to 120 A	0.0 to 90 A	0.0 to 62.5 A	0.0 to 37.5 A	0.0 to 24 A	0.0 to 15 A	0.0 to 12 A
RMS Ripple (mA)	200	120	90	62.5	37.5	24	500	12
Line Regulation (mA)	200	120	90	125	93.75	48	200	24
Load Regulation (mA)	800	480	375	250	150	96	400	48
P-P Ripple (mA)	N/A							
Drift (Temp Stability)	±0.05% of I <sub>out</sub> Rated over 8 hours, after 30 min warm-up, constant Line, Load, and Temp							
Temp Coefficient (PPM/°C)	SL, SQ = 300 PPM; All other modules are 200 PPM. Temp Coefficient at rack level is [Temp Coefficient (module level)] + [4500 PPM of I <sub>out-max</sub> ]							
Pgm Accuracy (A)	0.7% digital, 1.3% of rated output max analog							
Pgm Resolution (mA)	79.2	26.4	13.2	10	5.2	2.6		
Meas Accuracy	0.7% + 0.7% of Rated Output Max							
Meas Resolution	79.2	26.4	13.2	10	5.2	2.6		
Transient Response	0 to 63% output current change in 7.5 mSec, residual value 1%, settling time 35 mSec							
Current Sense Method	Internal Shunt							

**Ordering Information**

Case Code		Module Codes		Parallel/Series Case Code		Conf Code
iHP**XYA-		-XYZ* (x4/x8)		-XX-**		-X
Case Decoder	iHP**XYA	Module Decoder	XVZ	First Digit	Second Digit	Blank = Ship as a kit
** = Case PWR		X = Output Type		0 = None	0 = None	C = Ship Configured
12 = 12 KW 19" Rack 24 = 24 KW 19" Rack 24S = 24KW 19" Rack Short		S = Single O/P (1-Slot) T = Single O/P (3-Slot)		1 = Slot 1 & 2	P = Parallel	Any other Alpha Character = Special set-up configuration
X = Voltage Range		V = Nominal Voltage		2 = Slot 2 & 3	S = Series	<b>Mod Code</b>
L = Low Range 180 to 264 H = High Range 342 to 528 C = Canadian 540 to 660		A = 200V B = Future C = Future D = Future E = 5V L = 12V N = 15V Q = 24V T = 32V W = 48V 8 = 80V 1 = 125V 2 = 250V 3 = 300V (12KW ONLY) 5 = 500V (12KW ONLY) 9 = 825V (12KW ONLY)		3 = Slot 3 & 4	1 = Combo 2 P/S	-XXX
Y = Input Phase				4 = Slot 4 & 5	2 = Combo 2 S/P	Factory Assigned
1 = Single Phase 3 = 3 Phase				5 = Slot 5 & 6	3 = Combo 3 P/P/S	
Z = Cooling				6 = Slot 6 & 7	4 = Combo 3 P/S/P	
A = Air Cooled				7 = Slot 7 & 8	5 = Combo 3 P/S/S	
A = Accessory Options				8 = Slot 1, 2, & 3	6 = Combo 3 S/P/P	
Blank = Full control 1-9 = Future				9 = Slot 1, 2, 3, & 4	7 = Combo 3 S/P/S	
		Z = Mode		A = Slot 1, 2, 3, 4, & 5	8 = Combo 3 S/S/P	
		Blank = Standard		B = Slot 1, 2, 3, 4, 5, & 6	9 = Combo 4 P/P/P/S	
		P = Precision		C = Slot 1, 2, 3, 4, 5, 6, & 7	A = Combo 4 P/P/S/P	
				D = Slot 1, 2, 3, 4, 5, 6, 7, & 8	B = Combo 4 P/P/S/S	
				E = Slot 1 & 2; 3 & 4	C = Combo 4 P/S/P/P	
				F = Slot 1 & 2; 3 & 4; 5 & 6	D = Combo 4 P/S/P/S	
				G = Slot 1 & 2; 3 & 4; 5 & 6; 7 & 8	E = Combo 4 P/S/S/P	
				H = Slot 1, 2, & 3; 4 & 5	F = Combo 4 P/S/S/S	
				J = Slot 1, 2, & 3; 4 & 5; 6 & 7	G = Combo 4 S/P/P/P	
				K = Slot 1, 2, & 3; 4, 5, & 6	H = Combo 4 S/P/P/S	
				L = Slot 1, 2, & 3; 4, 5, & 6; 7 & 8	J = Combo 4 S/P/S/P	
				M = Slot 1, 2, 3, & 4; 5 & 6	K = Combo 4 S/P/S/S	
				N = Slot 1, 2, 3, & 4; 5 & 6; 7 & 8	L = Combo 4 S/S/P/P	
				P = Slot 1, 2, 3, & 4; 5, 6, & 7	M = Combo 4 S/S/P/S	
				R = Slot 1, 2, 3, & 4; 5, 6, 7, & 8	N = Combo 4 S/S/S/P	
				S = Slot 1, 2, 3, 4, & 5; 6 & 7		
				T = Slot 1, 2, 3, 4, & 5; 6, 7, & 8		
				U = Slot 1, 2, 3, 4, 5, & 6; 7 & 8		
				Z = Special Defined by MOD Code		
				-** is allowed for secondary series/parallel code		
				1 = Groups 1 & 2	P = Parallel	
				8 = Groups 1, 2, & 3	S = Series	
				9 = Groups 1, 2, 3, & 4	1 = Combo 2 P/S	
				E = Groups 1 & 2; 3 & 4	2 = Combo 2 S/P	

**MODEL NUMBER SHORTCUT**

For repeated like modules in parallel or series, instead of listing all the same modules separated by a “-”, you can simply list the module once and then follow by the number of times it repeats enclosed in parenthesis.

For example:

**iHP24H3A-SW-SW-SW-SW-SW-SW-S8-S8-00**

would become:

**iHP24H3A-SW(6)-S8(2)-00**

**PowerPro Connect Module**



**Part number:73-778-000A**

The PowerPro Connect Module (purchased separately) can provide standard Ethernet interface via the internet to a cloud- and dashboard-based user-configurable GUI.



# Intelligent Transfer Switch (iTS)

Up to 24000 Watts

## SPECIAL FEATURES

- 5-year manufacturer's warranty
- Modular 8 channel A:B switch
- Standard 19" rack
- Reversible mounting tabs
- Designed for use with iHP and LCM4000 product families
- 100% digital control
- Intelligent zero current switching when used with Artesyn devices
- Digital communication via RS485 (Modbus-RTU)
- Cloud based user configurable GUI
- Natural convection cooled (No Fan)
- Field upgradeable firmware
- Up to 16 racks are addressable from one control Node
- Configurable baud rate
- MTBF 400K hours per Telcordia SR-332 Method 1 Case 3, Part Stress
- Product lifetime 10 years minimum

### Total Power

Up to 24 KW

### Input Voltage

200 to 480 VAC Nominal  
Single Phase L - N  
or  
L1 and L2 of 3 - Phase

### # of Outputs:

Up to 8

### Safety

- EN62368-1
- UL/CSA62368-1
- IEC62368-1

### iTS Electrical Specifications – Housekeeping Power Supply Module

Parameter	Value
Description	The transfer switch has a built-in PSU to supply power to the relays and MCU module. It is designed to operate with 2 phases of a 3-PH input mains up to 480 VAC Nominal, or standard Phase and Neutral of single-phase mains.
AC Input Voltage	186 to 480 VAC Nominal (L1 and L2 of 3)
AC Input Frequency	50/60 Hz Nominal
AC Input Fusing	Included for both input AC lines (Not user serviceable)
AC Inrush Current	Upon start-up from a "cold start", the maximum AC input current shall Not exceed TBD Amps @ 480 V VAC 25C
Output to Relay Module	12 V @ 1 A per module; 3V3 as reference voltage ±1%

ITS Electrical Specifications – Relay Module	
Parameter	Value
Description	The relay is double break, capable for 25 A max continuous operation. Both output lines, positive and return, are switched. To prevent arcing, the relay is only switched when zero voltage / zero current is flowing through the contacts (Provided by master software control of the power source and Relay MCU.) The relay module shall support iHP modules with Nominal voltage rating of 125 VDC, 200 VDC and 250 VDC along with the 250 VAC output of the LCM4000HV. iHP modules connected in series for higher voltage output is allowed, but the load maybe derated so as Not to exceed the switching power rating of the relay.
# Inputs	One per relay module, up to 8 can be loaded in a single 2U rack
Nominal Input Voltage	125 to 250 V
Input Current Max	25 A
Input Current Fault	>28 A

Ordering Information	
Model	Configuration
73-779-008	Fully configured, Rack with 8 relay modules
73-779-007	Rack with 7 relay modules
73-779-006	Rack with 6 relay modules
73-779-005	Rack with 5 relay modules
73-779-004	Rack with 4 relay modules
73-779-003	Rack with 3 relay modules
73-779-002	Rack with 2 relay modules
73-779-001	Rack with 1 relay module
73-779-000	Relay module only
73-779-TBD	Blank relay module



# LCM300

## Bulk Front End

### 300 Watts

#### SPECIAL FEATURES

- 300 W (350 W some models)
- Low cost
- 1.61" x 4.0" x 7.0"
- 7.1 W/in<sup>3</sup>
- Industrial/Medical safety
- -40 to 70°C with derating
- Optional 5 V @ 2 A housekeeping
- High efficiency: 91% @ 230 VAC
- Variable speed "Smart Fans"
- DSP controlled
- PMBus™ compliant
- Conformal coat option
- ±20% adjustment range
- Margin programming (300 W and 600 W models)
- OR-ing FET
- EMI Class B
- EN61000 immunity
- RoHS 2

#### Total Power

300 W (350 W some models)

#### # of Outputs

Single

#### Output

12 to 60 V

Optional 5.0 V standby

#### Safety

- UL 60950-1  
508/1598/1433  
60601-1 Ed 3
- CSA 60950-1
- VDE 60950-1  
60601
- China CCC
- CB Scheme Report/Cert

#### Electrical Specifications

Input	
Input Range	90 to 264 VAC (Operating) (127 to 374 VDC) 115/230 VAC (Nominal) TERMINAL BLOCK
Frequency	47 to 63 Hz, Nominal 50/60
Input Fusing	Internal 8 A fuses, both lines fused
Inrush Current	≤ 20 A peak, either hot or cold start
Power Factor	0.98 typical, meets EN61000-3-2
Harmonics	Meets IEC 1000-3-2 requirements
Input Current	5 Arms max input current, @ 90 VAC
Hold up Time	20 ms minimum for Main O/P, @ full rated load
Efficiency	> 91% typical @ full Load/230 VAC Nominal
Leakage Current	< 0.3 mA @ 264 VAC
ON/OFF Power Switch	N/A
Power Line Transient	MOV directly after the fuse
Isolation	PRI-Chassis 2500 VDC Basic PRI-SEC 4000 VAC Reinforced 2xMOPP SEC-Chassis 500 VDC



Environmental Specifications	
Operating Temperature	-40 to +70°C, linear derating to 50% from 50 to 70°C
Storage Temperature	-40 to +85°C
Humidity	20 to 90%, Non-condensing. Operating. conformal coat option available
Fan Noise	< 45 dBA, 80% load @ 40°C; fan off when unit is inhibited
Altitude	Operating - 16,405 ft (5000 m) Storage - 30,000 ft
Shock	MIL-STD-810F 516.5, Procedure I, VI. storage
Vibration	MIL-STD-810F 514.5, Cat. 4, 10. storage

Electrical Specifications		
Output		
Output Rating	See ordering information table below	90 to 264 VAC
Set Point	±0.5%	90 to 264 VAC
Total Regulation Range	Main output ±2% 5 Vsb ±1%	Combined line/load/transient when measured at output terminal
Rated Load	310 W maximum	Derate linear to 50% from 50 to 70°C
Minimum Load	Main output @ 0.0 A 5 Vsb @ 0.0 A	No loss of regulation
Output Noise (PARD)	1% max p-p 50 mV max p-p	Main output 5 Vsb output Measured with a 0.1 µF ceramic and 10 µF tantalum capacitor on any output, 20 MHz
Output Voltage Overshoot	—	No overshoot/undershoot outside the regulation band during on or off cycle
Transient Response	< 300 µs	50% load step @ 1 A/µs Step load valid between 10% to 100% of output rating Recovery time to within 1% of set point at onset of transient
Max Units in Parallel	—	Up to 10
Short Circuit Protection	Protection against damage	Bounce mode
Remote Sense	—	Compensation up to 500 mV
Output Isolation	—	Standard per safety requirements
Forced Load Sharing	To within 10% of all shared outputs	Analog sharing control
Over-Load Protection (OCP)	105% to 125% 120% to 170%	Main output 5 Vsb output. Constant current or hiccup mode (software selectable)
Over-Voltage Protection (OVP)	125% to 145% 110% to 125%	12 V output 5 Vsb output
Over-Temperature Protection	10 to 15°C above safe operating area	Both PFC and output converter monitored

Ordering Information									
Model Number <sup>1</sup>	Output	Nominal Output Voltage Set Point	Set Point Tolerance	Adjustment Range	Current Min	Max	Output Ripple P/P (0 to 50°C)	Max Continuous Power	Combined Line/Load Regulation
LCM300L	12 V	12 V	±0.5%	9.6 to 14.4 V	0 A	25 A	120 mV	310	2%
LCM300N	15 V	15 V	±0.5%	12.0 to 19.5 V	0 A	20 A	150 mV	310	2%
LCM300Q	24 V	24 V	±0.5%	19.2 to 28.8 V	0 A	12.5 A	240 mV	310	2%
LCM300U	36 V	36 V	±0.5%	28.8 to 43.2 V	0 A	8.4 A	360 mV	310	2%
LCM300W	48 V	48 V	±0.5%	38.4 to 57.6 V	0 A	6.3 A	480 mV	310	2%

<sup>1</sup> For option codes, see Data Sheet



# LCM600

## Bulk Front End

### 600 Watts

#### SPECIAL FEATURES

- 600 W output power
- Low cost
- 2.4" x 4.5" x 7.5"
- 7.41 W/in<sup>3</sup>
- 5 V SELV standby (housekeeping)
- Industrial/Medical safety
- -40 to 70°C with derating
- 5 V housekeeping
- High efficiency: 89% typical
- Variable speed "Smart Fans"
- DSP controlled front end
- Conformal coat option
- ±20% adjustment range
- Margin programming
- OR-ing FET option
- Terminal block input option

#### Total Power

600 Watts

#### # of Outputs

Single

#### Output

9.6 to 60 V

Optional 5.0 V standby

#### Safety

- UL 60950-1  
508/1598/1433  
60601-1
- CSA 60950-1
- VDE 60950-1  
60601
- China CCC
- CB Scheme Report/Cert

#### Electrical Specifications

Input	
Input Range	85 to 264 VAC (Operating) 115/230 VAC (Nominal) Input through standard IEC connector
Frequency	47 to 440 Hz, Nominal 50/60
Input Fusing	Internal 10 A fuses, both lines fused
Inrush Current	≤ 25 A peak, either hot or cold start
Power Factor	0.99 typical, meets EN61000-3-2
Harmonics	Meets IEC 1000-3-2 requirements
Input Current	8 A RMS max input current, at 100 VAC
Hold up Time	20 ms minimum for Main O/P, at full rated load
Efficiency	> 88% at full load
Leakage Current	< 0.3 mA at 264 VAC
ON/OFF Power Switch	N/A
Power Line Transient	MOV directly after the fuse

#### Environmental Specifications

Operating Temperature	-40 to +70°C, linear derating to 50% from 50 to 70°C
Storage Temperature	-40 to 85°C
Humidity	20 to 90%, Non-condensing. Operating. Conformal coat option available
Fan Noise	< 45 dBA, 80% load at 30°C
Altitude	Operating: Up to 16,405 ft above sea level Storage: Up to 30,000 ft above sea level
Shock	MIL-STD-810F 516.5, Procedure I, VI. Storage
Vibration	MIL-STD-810F 514.5, Cat. 4, 10. Storage

Electrical Specifications		
Output		
Output Rating	See ordering information table below	85 to 264 VAC
Set Point	±0.5%	85 to 264 VAC
Total Regulation Range	Main output ±2% 5 Vsb ±1%	Combined line/load/transient when measured at output terminal
Rated Load	600 W maximum	Derate linear to 50% from 50 to 70°C
Minimum Load	Main output @ 0.0 A 5 Vsb @ 0.0 A	No loss of regulation
Output Noise (PARD)	1% max p-p 50 mV max p-p	Main output 5 Vsb output Measured with a 0.1 µF ceramic and 10 µF tantalum capacitor on any output, 20 MHz
Output Voltage Overshoot	—	No overshoot/undershoot outside the regulation band during on or off cycle
Transient Response	< 300 µs	50% load step @ 1 A/µs Step load valid between 10% to 100% of output rating Recovery time to within 1% of set point at onset of transient
Max Units in Parallel	—	Up to 10
Short Circuit Protection	Protection against damage	Bounce mode
Remote Sense	—	Compensation up to 500 mV
Output Isolation	—	Standard per safety requirements
Forced Load Sharing	To within 10% of all shared outputs	Analog sharing control
Over-load Protection (OCP)	105% to 125% 120% to 170%	Main output 5 Vsb output. Constant current or bounce mode option through software
Over-voltage Protection (OVP)	125% to 145% 110% to 125%	12 V output 5 Vsb output
Over-temperature Protection	10 to 15°C above safe operating area	Both PFC and output converter monitored

Ordering Information								
Model Number <sup>1</sup>	Output	Nominal Output Voltage Set Point	Set Point Tolerance	Adjustment Range	Current		Output Ripple P/P (0 to 50°C)	Combined Line/ Load Regulation
					Min	Max		
LCM600L	12 V	12 V	±0.5%	9.6 to 14.4 V	0 A	54 A	120 mV	2%
LCM600N	15 V	15 V	±0.5%	12.0 to 19.5 V	0 A	44 A	150 mV	2%
LCM600Q	24 V	24 V	±0.5%	19.2 to 28.8 V	0 A	27 A	240 mV	2%
LCM600U	36 V	36 V	±0.5%	28.8 to 43.2 V	0 A	16.7 A	360 mV	2%
LCM600W	48 V	48 V	±0.5%	38.4 to 57.6 V	0 A	14 A	480 mV	2%

<sup>1</sup> For option codes, see Data Sheet



# LCM1000

**Bulk Front End**  
**1000 Watts**

## SPECIAL FEATURES

- 1000 W output power
- Low cost
- 2.5" x 5.2" x 10.0"
- 7.7 W/in<sup>3</sup>
- Industrial/Medical safety
- -40 to 70°C with derating
- Optional 5 V @ 2 A housekeeping
- High efficiency: 90% typical
- Variable speed "Smart Fans"
- DSP controlled
- Conformal coat option
- ±10% adjustment range
- Margin programming
- OR-ing FET
- Low acoustic Noise

### Total Power

1000 W

### # of Outputs

Single

### Output

12 to 48 V

Optional 5.0 V standby

### Safety

- ULcUL Recognized ITE (UL60950-1)
- ULcUL Recognized Medical (ANSI/AAMI ES60601-1)
- TUV-SuD ITE + Medical (EN60950-1 and EN60601-1)
- CE LVD (EN60950-1 + ROHS)
- BSMI
- CB Report
  - Through Demko for IEC60950-1
  - Through TUV-SuD for IEC60601-1
- CCC Approval

## Electrical Specifications

Input	
Input Range	90 to 264 VAC (Operating) 115/230 VAC (Nominal) TERMINAL BLOCK
Frequency	47 to 440 Hz, Nominal 50/60
Input Fusing	Internal 20 A fuses, both lines fused
Inrush Current	≤ 25 A peak, either hot or cold start
Power Factor	0.99 typical, meets EN61000-3-2
Harmonics	Meets IEC 1000-3-2 requirements
Input Current	12 A RMS max input current, at 100 VAC
Hold up Time	20 ms min for Main O/P, @ full rated load
Efficiency	> 90% typical @ full load / 230 VAC Nominal
Leakage Current	< 0.4 mA at 264 VAC
ON/OFF Power Switch	N/A
Power Line Transient	MOV directly after the fuse
Isolation	PRI-Chassis 2500 VDC Basic PRI-SEC 4000 VAC Reinforced 2xMOPP SEC-Chassis 500 VDC

## Environmental Specifications

Operating Temperature	-40 to +70°C, linear derating to 75% from 60 to 70°C
Storage Temperature	-40 to +85°C
Humidity	20 to 90%, Non-condensing. Operating. Conformal coat option available
Fan Noise	< 45 dBA, 100% load at 30°C
Altitude	Operating - 16,405 ft (5000 m) Storage - 30,000 ft
Shock	MIL-STD-810F 516.5, Procedure I, VI. Storage
Vibration	MIL-STD-810F 514.5, Cat. 4, 10. Storage

Electrical Specifications		
Output		
Output Rating	See table 1	90 to 264 VAC
Set Point	±0.5%	90 to 264 VAC
Total Regulation Range	Main output ±2% 5 Vsb ±1%	Combined line/load/transient when measured at output terminal
Rated Load	1000 W maximum	Derate linear to 50% from 50 to 70°C
Minimum Load	Main output @ 0.0 A 5 Vsb @ 0.0 A	No loss of regulation
Output Noise (PARD)	1% max p-p 50 mV max p-p	Main output 5 Vsb output Measured with a 0.1 µF Ceramic and 10 µF Tantalum Capacitor on any output, 20 MHz
Output Voltage Overshoot	—	No overshoot/undershoot outside the regulation band during on or off cycle
Transient Response	< 300 µSec	50% load step @ 1 A/µs Step load valid between 10% to 100% of output rating Recovery time to within 1% of set point at onset of transient
Max Units in Parallel	—	Up to 10
Short Circuit Protection	Protected, No damage to occur	Bounce mode
Remote Sense	—	Compensation up to 500 mV
Output Isolation	—	Standard per safety requirements
Forced Load Sharing	To within 10% of all shared outputs	Analog sharing control
Over-load Protection (OCP)	105% to 125% 120% to 170%	Main output 5 Vsb output
Over-voltage Protection (OVP)	125% to 145% 110% to 125%	12 V output 5 Vsb output
Over-temperature Protection	10 to 15°C above safe operating area	Both PFC & output converter monitored

Ordering Information									
Model Number <sup>1</sup>	Output	Nominal Output Voltage Set Point	Set Point Tolerance	Adjustment Range	Current		Output Ripple P/P (0 to 50°C)	Max Continuous Power	Combined Line/Load Regulation
					Min	Max			
LCM1000L	12 V	12 V	±0.5%	10.8 to 13.2 V	0 A	83.3 A	120 mV	1000 W	2%
LCM1000N	15 V	15 V	±0.5%	13.5 to 16.5 V	0 A	66.7 A	150 mV	1000 W	2%
LCM1000Q	24 V	24 V	±0.5%	21.6 to 26.4 V	0 A	41.7 A	240 mV	1000 W	2%
LCM1000U	36 V	36 V	±0.5%	32.4 to 39.6 V	0 A	27.8 A	360 mV	1000 W	2%
LCM1000W	48 V	48 V	±0.5%	43.2 to 52.8 V	0 A	20.8 A	480 mV	1000 W	2%

<sup>1</sup> For option codes, see Data Sheet



# LCM1500

**Bulk Front End**  
**1500 Watts**

## SPECIAL FEATURES

- 1500 W output power
- Low cost
- 2.5" x 5.2" x 10.0"
- 12 Watts per in<sup>3</sup>
- Industrial/Medical safety
- -40 to 70°C with derating
- Optional 5 V @ 2 A housekeeping
- High efficiency: 89% typical
- Variable speed "Smart Fans"
- DSP controlled
- Conformal coat option
- ±10% adjustment range
- Margin programming
- OR-ing FET
- Change to EMI Class A
- EN61000 immunity
- RoHS 2
- PMBUS

### Total Power

1500 W

### # of Outputs

Single

### Output

12 to 60 V

Optional 5.0 V standby

### Safety

- UL 60950-1  
508/1598/1433  
60601-1 Ed 3
- CSA 60950-1
- VDE 60950-1  
60601
- CB Scheme Report/Cert

## Electrical Specifications

Input	
Input Range	90 to 264 VAC (Operating) 115/230 VAC (Nominal) TERMINAL BLOCK
Frequency	47 to 440 Hz, Nominal 50/60
Input Fusing	Internal 20 A fuses, both lines fused
Inrush Current	≤ 25 A peak, either hot or cold start
Power Factor	0.99 typical, meets EN61000-3-2
Harmonics	Meets IEC 1000-3-2 requirements
Input Current	18 Arms max input current, @ 100 VAC
Hold up Time	20 ms min for Main O/P, @ full rated load
Efficiency	> 91% typical @ full Load/230 VAC Nominal
Leakage Current	< 0.3 mA @ 264 VAC
ON/OFF Power Switch	N/A
Power Line Transient	MOV directly after the fuse
Isolation	PRI-Chassis 2500 VDC Basic PRI-SEC 2500 VDC Reinforced SEC-Chassis 500 VDC

## Environmental Specifications

Operating Temperature	-40 to +70°C, linear derating to 50% from 50 to 70°C
Storage Temperature	-40 to +85°C
Humidity	20 to 90%, Non-condensing. Operating. Conformal coat option available
Fan Noise	< 45 dBA, 80% load @ 30°C
Altitude	Operating - 16,405 ft (5000 m) Storage - 30,000 ft
Shock	MIL-STD-810F 516.5, Procedure I, VI. Storage
Vibration	MIL-STD-810F 514.5, Cat. 4, 10. Storage

Electrical Specifications		
Output		
Output Rating	See ordering information table below	90 to 264 VAC
Set Point	±0.5%	90 to 264 VAC
Total Regulation Range	Main output ±2% 5 Vsb ±1%	Combined line/load/transient when measured at output terminal
Rated Load	1500 W maximum	Derate linear to 50% from 50 to 70°C
Minimum Load	Main output @ 0.0 A 5 Vsb @ 0.0 A	No loss of regulation
Output Noise (PAR)	1% max p-p 50 mV max p-p	Main output 5 Vsb output Measured with a 0.1 µF ceramic and 10 µF tantalum capacitor on any output, 20 MHz
Output Voltage Overshoot	—	No overshoot/undershoot outside the regulation band during on or off cycle
Transient Response	< 300 µs	50% load step @ 1 A/µs Step load valid between 10% to 100% of output rating Recovery time to within 1% of set point at onset of transient
Max Units in Parallel	—	Up to 10
Short Circuit Protection	Protection against damage	Bounce mode
Remote Sense	—	Compensation up to 500 mV
Output Isolation	—	Standard per safety requirements
Forced Load Sharing	To within 10% of all shared outputs	Analog sharing control
Over-load Protection (OCP)	105% to 125% 120% to 170%	Main output 5 Vsb output. Constant current or bounce mode option through software.
Over-voltage Protection (OVP)	125% to 145% 110% to 125%	12 V output 5 Vsb output
Over-temperature Protection	10 to 15°C above safe operating area	Both PFC and output converter monitored

Ordering Information									
Model Number <sup>1</sup>	Output	Nominal Output Voltage Set Point	Set Point Tolerance	Adjustment Range	Current Min	Max	Output Ripple P/P (0 to 50°C)	Max Continuous Power	Combined Line/Load Regulation
LCM1500L	12 V	12 V	±0.5%	10.8 to 13.2 V	0 A	133 A	120 mV	1500	2%
LCM1500N	15 V	15 V	±0.5%	13.5 to 16.5 V	0 A	100 A	150 mV	1500	2%
LCM1500Q	24 V	24 V	±0.5%	21.6 to 26.4 V	0 A	67 A	240 mV	1500	2%
LCM1500R	28 V	28 V	±0.5%	25.2 to 30.8 V	0 A	53.6 A	280 mV	1500	2%
LCM1500U	36 V	36 V	±0.5%	32.4 to 39.6 V	0 A	43 A	360 mV	1500	2%
LCM1500W	48 V	48 V	±0.5%	43.2 to 52.8 V	0 A	33 A	480 mV	1500	2%

<sup>1</sup> For option codes, see Data Sheet



# LCM3000

**Bulk Front End**  
**3000 Watts**

## SPECIAL FEATURES

- 3000 W output power
- Low cost
- 2.5" x 7.0" x 10.9"
- 15.7 W/in<sup>3</sup>
- Industrial/Medical safety
- -40 to 70°C with derating
- Optional 5 V @ 2 A housekeeping
- High efficiency: 91% typical
- Variable speed "Smart Fans"
- DSP controlled
- Conformal coat option
- ±25% adjustment range
- Margin programming
- VAR configurable to any voltage from a single unit
- Five-year warranty

### Total Power

**3000 W**

### # of Outputs

**Single**

### Output

**12 to 48 V**

### Safety

- UL/cUL Recognized ITE (UL60950-1)
- UL/cUL Recognized Medical (ANSI/AAMI ES60601-1)
- TUV-SuD ITE + Medical (EN60950-1 and EN60601-1)
- CE LVD (EN60950-1 + RoHS)
- CQC under GB17625.1, GB4943, GB9254
- CB Report
  - through Demko for IEC60950-1
  - through TUV-SuD for IEC60601-1
  - through DEMKO for IEC62368-1

## Electrical Specifications

### Input

Input Range	90 to 264 VAC (Operating) Derate to 1500 W below 180 VAC input 115/230 VAC (Nominal) 129 to 370 VDC TERMINAL BLOCK
Frequency	47 to 440 Hz, Nominal 50/60
Input Fusing	Internal 30 A fuses, both lines fused
Inrush Current	≤ 35 A peak, @ 110 VAC & <60 A @ 230 VAC
Power Factor	0.99 typical, meets EN61000-3-2
Harmonics	Meets IEC 1000-3-2 requirements
Input Current	20 A RMS max input current, @ 100 VAC
Hold Up Time	14 ms min for Nominal output voltage, @ full rated load
Efficiency	> 91% typical @ full load / 230 VAC Nominal
Leakage Current	< 0.4 mA at 264 VAC
ON/OFF Power Switch	N/A
Power Line Transient	MOV directly after the fuse
Isolation	PRI-Chassis 2500 VDC Basic PRI-SEC 4000 VAC Reinforced 2xMOPP SEC-Chassis 500 VDC

## Environmental Specifications

Operating Temperature	-40 to +70°C, linear derating to 50% from 50°C to 70°C. Operation at -40°C requires a 5 min operating warm-up @ -20°C
Storage Temperature	-40 to +85°C
Humidity	10 to 90%, Non-condensing. Operating. Conformal coat option available.
Acoustic Noise	< TBD dBA, 80% load @ 30°C
Altitude	Operating - 16,405 ft (5000 m) Storage - 30,000 ft
Shock	MIL-STD-810F 516.5, Procedure I, VI.
Vibration	MIL-STD-810F 514.5, Cat. 4, 10.



Electrical Specifications		
Output		
Output Rating	See table 1	180 to 264 VAC
Set Point	±0.5%	90 to 264 VAC
Total Regulation Range	Main output ± 1% 5 Vsb ± 5%	Combined line/load when measured at output terminal
Rated Load	3000 W maximum (Derate to 2000 W when input is <180 VAC)	Derate linear to 50% from 50 to 70°C
Minimum Load	Main output @ 0.0 A 5 Vsb @ 0.0 A	No loss of regulation
Output Noise (PARD)	1% max p-p 100 mV max p-p	Main output 5 Vsb output Measured with a 0.1 µF Ceramic and 10 µF Tantalum Capacitor on any output, 20 MHz
Output Voltage Overshoot	<3% of voltage setting must settle within 300 mSec	Rise is monotonic
Transient Response	< 300 µSec	50% load step @ 1 A/µs Step load valid between 10% to 100% of output rating Recovery time to within 1% of set point at onset of transient
Max Units in Parallel	—	Up to 8
Short Circuit Protection	Protected, No damage to occur	Bounce mode
Remote Sense	—	Compensation up to 500 mV
Output Isolation	—	Standard per safety requirements
Forced Load Sharing	To within 10% of all shared outputs	Digital sharing control
Over-load Protection (OCP) – Constant Current Mode	105% to 125% 120% to 170%	Main output 5 Vsb output
Over-voltage Protection (OVP)	125% to 145% 110% to 125%	12 V output 5 Vsb output
Over-temperature Protection	10 to 15°C above safe operating area	Both PFC and output converter monitored

Ordering Information								
Model Number	Nominal Output Voltage Set Point	Adjustment Range		Max I	Output Ripple P/P (0 to 50°C)	Combined Line/Load Regulation	Trim Range ± 25%	“Vprog Adjustment” 0 V to 6 V (20% to 125% Vout)
		Max I	Max Power (3000 W)					
LCM3000L-T	12 V	2.4 to 12 V	12 to 15 V	250 A	120 mV or 1%, whichever is higher	1%	9 to 15 V	2.4 to 15 V
LCM3000O-T	18 V	3.6 to 18 V	18 to 22.5 V	166.7 A	180 mV or 1%, whichever is higher	1%	13.5 to 22.5 V	3.6 to 22.5 V
LCM3000Q-T	24 V	4.8 to 24 V	24 to 30 V	125 A	240 mV or 1%, whichever is higher	1%	18 to 30 V	4.8 to 30 V
LCM3000U-T	36 V	7.2 to 36 V	36 to 45 V	83.3 A	360 mV or 1%, whichever is higher	1%	27 to 45 V	7.2 to 45 V
LCM3000W-T	48 V	9.6 to 48 V	48 to 60 V	62.5 A	480 mV or 1%, whichever is higher	1%	36 to 60 V	9.6 to 60 V
LCM30007-T	72 V	14.4 to 72 V	72 to 90 V	41.7 A	720 mV or 1%, whichever is higher	1%	54 to 90 V	14.4 to 90 V

<sup>1</sup> Minimum Current is (0)

<sup>2</sup> Set Point Tolerance is ±0.5%

<sup>3</sup> Outputs above 60 VDC are Not SELV rated.



## Xsolo

### Ultra-compact, High-efficiency 500 W and 1000 W Single Output Power Supplies

#### SPECIAL FEATURES

- Single output voltages are 24 V, 36 V, or 48 V with wide adjustment ranges and user-defined set-points
- Ultra high efficiency, > 92%
- Low profile: 1U height (40 mm)
- Convection-cooled 500 W
- Fan-cooled 1000 W (variable speed fan)

#### TYPICAL APPLICATIONS

- Industrial
- Test and measurement
- Acoustically sensitive laboratory and medical environments
- Hi-Rel MIL-COTS
- Communication

#### Total Power

- XS500 504 W
- XS1000 1008 W

#### Output Voltage

24, 36, 48  
24, 36, 48

#### Safety

- IEC60601-1 2nd and 3rd edition
- IEC60601-1-2 4th edition (EMC)
- IEC60950 2nd edition
- 2 MOPP
- SEMI F47<sup>1</sup>
- MIL-STD-810G<sup>2</sup>

<sup>1</sup> SEMI F47 compliant at input voltages > 160 VAC. Consult Advanced Energy for details.

<sup>2</sup> Consult Advanced Energy for MIL810G report (enhanced ruggedisation available as an option).

## Ordering Information

Model	Power (W)	Output Voltage	Output Current (A)	Medical Approval UL/EN60601-1, 3rd Edition	Industrial Approval UL/EN60950, 2nd Edition
XS500-24	504	24	21.0	Yes	Yes
XS1000-24	1008	24	42.0	Yes	Yes
XS500-36	504	36	14.0	Yes	Yes
XS1000-36	1008	36	28.0	Yes	Yes
XS500-48	504	48	10.5	Yes	Yes
XS1000-48	1008	48	21.0	Yes	Yes

Model	Vnom (W)	Description	Set Point Adjust Range (V)	Dynamic Vtrim Range (V)	I <sub>max</sub> (A)	Remote Sense	Power Good
XS500-24	24	Convection-cooled U-channel	19 to 28	14 to 28	21.0	Yes	Yes
XS1000-24	24	Enclosed fan-cooled	19 to 28	14 to 28	42.0	Yes	Yes
XS500-36	36	Convection-cooled U-channel	26 to 40	20 to 40	14.0	Yes	Yes
XS1000-36	36	Enclosed fan-cooled	26 to 40	20 to 40	28.0	Yes	Yes
XS500-48	48	Convection-cooled U-channel	36 to 58	29 to 58	10.5	-	Yes
XS1000-48	48	Enclosed fan-cooled	36 to 58	29 to 58	21.0	Yes	Yes

## Environmental Specifications

Parameter	Conditions/Description	Min	NOM	Max	Units
Operating Temperature	-40	—	+70	—	°C
Storage Temperature	-40	—	+85	—	°C
Derating	See the designer's manual for full temperature deratings	—	—	—	—
Relative Humidity	Non-condensing	5	—	95	% RH
Shock and Vibration	Designed to meet MIL810 G <sup>1</sup>	—	55	—	G
Altitude	EN60601-1 Operational: 3000 m, Storage 8000 m	—	3000	—	m
	EN60950 Operational: 5000 m, Storage 8000 m	—	5000	—	m

<sup>1</sup> Consult Advanced Energy for MIL810G report (enhanced ruggedization available as an option).



HPS3000

### Safety

- UL UL60950 (UL recognized)
- NEMKO EN60950
- TÜV EN60950
- CE Mark
- CB Report

## HPS & UFE

Distributed Power Bulk Front End  
3000 to 12000 Watts

### SPECIAL FEATURES

- EN61000-3-2 harmonic compliance
- Built-in EMI filter
- Low output ripple
- +5 V standby output
- Built-in cooling fans
- N + 1 redundant
- Over-current protection
- Over-voltage protection
- Over-temperature protection
- Built-in OR-ing diodes
- Active power factor correction

Voltage Availability		
Model	HPS3000	UFE
Wattage	3000 W <sup>3</sup>	2000 W <sup>4</sup>
Input Voltage	90 to 140 VAC 180 to 264 VAC	90 to 265 VAC
Available Standard Output Voltages (order code) <sup>1</sup>		
12 (L)		
24 (Q)		•
28 (R)		•
30 (S)		
48 (W)	•	•
54 (X)		•
60 (Y)		
Available Options	See Note 1	
Corresponding Rack	See Note 2	UFR6000J

HPS3000 Electrical Specifications	
Input	
Input Range (Operating)	180 to 264 VAC 90 to 140 VAC
Input Range (Nominal)	200 VAC 110 VAC
Frequency	43 to 63 Hz
Input Fusing	Internal 25 A fuses (both lines fused)
Inrush Current	≤ 40 A peak (either hot or cold start)
Power Factor	0.97 typical (Meets EN61000-3-2)
Harmonics	Meets IEC 1000-3-2 requirements @ 50% load
Input Current	19 A max input current
Holdup Time	10 ms min @ full rated load
Leakage Current	1.4 mA @ 240 VAC
Power Line Transient	MOV directly after the fuse

<sup>1</sup> Consult factory for other output voltages and options

<sup>2</sup> Comes with optional I<sup>2</sup>C interface

<sup>3</sup> 3000 W @ 180 to 264 VAC; 1500 W @ 90 to 140 VAC

<sup>4</sup> 2000 W @ 48 V; 1300 W @ 24 V

Environmental Specifications	
<b>HPS3000</b>	
Operating Temp.	-10 to 40°C
Storage Temp.	-40 to 85°C
Cooling	External fans with Fan Fail and Fan Speed control
Humidity	Operating/Storage: 5 to 95% Non-condensing
Altitude	Operating: Up to 10,000 ft above sea level Storage: Up to 30,000 ft above sea level
Vibration/Shock	Non-operational 5G Sine sweep from 5 to 500 Hz, dwelling at resonant frequencies for one hour each
RoHS Compliant	Yes
<b>Output</b>	
Output Rating	48 V @ 62.0 A (180 to 264 VAC) 5 Vsb @ 3.0 A 48 V @ 29.4 A (90 to 140 VAC) 5 V @ 3 A
Set Point	-4% to +17% through I <sup>2</sup> C
Total Regulation Range	48 V ±10%; 5 Vsb ±4% (line/load/transient when measured at output connection)
Rated Load	3000 W max @ 200 VAC Input 1500 W max @ 110 VAC Input (No derating over operating temperature range)
Minimum Load	48 V @ 0.0 A; 5 Vsb @ 0.0 A with No loss of regulation
Output Noise	480 mV max P-P for 48 V output 100 mV max P-P for 5 Vsb output Measured with a 0.1F Ceramic and 10 F Tantalum capacitor on any input
Output Voltage Overshoot	±5% maximum of Nominal voltage setting
Transient Response	5% maximum deviation (50% load step @ 1 A/μs. Step load valid between 10 to 100% of output rating)
Max Units in Parallel	Up to 4 (total power in 1U 19" rack is 12 KW)
Short Circuit Protection	120 to 130% of rated output (output to return)
Forced Load Sharing	Within 10% of all shared outputs (digital sharing control)
Over-current Protection (OCP)	120 to 130% for 48 V output 100 to 125% for 5 Vsb output
Over-voltage Protection (OVP)	110 to 120% for 48 V output 110 to 125% for 5 Vsb output
Over-temperature Protection	10 to 15°C above safe operating area. (Both PFC and output converter monitored. 5 Vsb will operate under over-temperature condition. Built-in hysteresis.)



HPR12K

## BULK POWER

Rack Ordering Information <sup>1</sup>		
Module	UFE1300/2000	HPS3000
Rack #	UFR6000	HPR12K
# of Slots	3	4
Total Power	6000 W	12000 W

Ordering Information		
HPS3000-9-001	High airflow performance	HPR120K-00-001
HPS3000-9	Standard fans	HPR12K-00

UFE1300/2000 Electrical Specifications		
Input		
Input Range (Operating)	88 to 264 VAC	
	176 to 264 VAC	
Input Range (Nominal)	120 VAC	
	240 VAC	
Frequency	47 to 63 Hz	
Input Fusing	30 A (both lines fused)	
Power Factor	0.98 (50 to 100% load)	
Input Current	15 A max	
Leakage Current	2 mA max	
Over-voltage Lockout (power up)	High Line Range	176 VAC max
	Wide Range	88 VAC max
Over-voltage Lockout (power down)	High Line Range	162 VAC min
	Wide Range	76 VAC min
Output		
Output Rating - Main Output	48 V 2000 W (high line range) 48 V 1300 W (wide range) 24 V 1300 W (all ranges)	
Output Rating - Auxiliary Output	11 V ±15%, 2,875 W	
Line Regulation	±0.15% max	
Load Regulation	±0.15% max	
Turn-on Delay	5.0 sec max	
Ambient Temp. Coefficient	±0.005%/°C	
Voltage Adjustability (via PMBus)	48 V 42 to 57 VDC or 24 V 21 to 28.5 VDC	
Output Setpoint Accuracy	±0.5%	
Default Output Voltage (@ 25°C)	48 V ±0.5% @ 41 A or 27 V ±0.5% @ 48 A	
Total Error Band	±1.0% max	
Overshoot/Undershoot	0%	
Ripple and Noise (20 MHz)	500 mV pk-pk, 150 mV rms	
Dynamic Regulation	2.5% max, recovery in 1 ms max (except droop mode)	
Current Sharing	15% max	
Electrical Insulation	4242 VDC input/output	
Switching Frequency	450 kHz fixed	
Power Limit	115%	
Current Limit	108% typical	
Short-circuit	200 ms on; 1/8 second off	
Over-voltage	60 V/32 V	
Over-temperature	Non-latching	

<sup>1</sup> See website for option codes on HPR racks.

**Ordering Information**

Rated Output Power	Output Voltage Vout		Output Current (Min)	Power Limit + 15% / -0% Vout (min)	Line Range at Turn On (Auto Ranging)	Operating Line Range	Current Limit (Vout) < Vout (min)	Model Numbers	Order Number
	Min	Max							
<b>24 Vout Models</b>									
1300 W	21 V	28.5 V	0 A	1300 W	90 to 264 VAC	65 A	65 A	UFE1300-96S24PJ	UFE1300-5
<b>48 Vout Models</b>									
1300 W	42 V	57 V	0 A	1300 W	90 to 264 VAC	33 A	33 A	UFE2000-96S48PJ	UFE2000-9
2000 W	42 V	57 V	0 A	2000 W	180 to 264 VAC	52 A	52 A		
1300 W	42 V	57 V	0 A	1300 W	90 to 264 VAC	33 A	33 A	UFE2000-96S48PDJ	UFE2000-9-HD
2000 W	42 V	57 V	0 A	2000 W	180 to 264 VAC	52 A	52 A		
1300 W	42 V	57 V	0 A	1300 W	90 to 264 VAC	33 A	33 A	UFE2000-96S48PHDJ	UFE2000-9-D
2000 W	42 V	57 V	0 A	2000 W	180 to 264 VAC	52 A	52 A		

Product Family	Rated Output Power	Input Range	Standard Compliance	Type of Output	Output Voltage	Communications Type	Option Code	Special Modification	RoHS Compliance
<b>UFE</b>	<b>2000</b>	<b>9</b>	<b>6</b>	<b>S</b>	<b>48</b>	<b>P</b>	<b>D</b>	<b>XX</b>	<b>J</b>
UFE = Universal Front-End	1300 = 1300 Watts 2000 = 2000 Watts	9 = Universal Input with PFC	6 = UL/CSA/VDE Class A/B	S = Single	48 = 48 V 24 = 24 V	P = PMBus serial communications	None = Active Ishare D = Droop Ishare HD = PS Enable HI/Droop		J = Pb free (RoHS 6/6 compliant)

UFE Power Shelf



UFE2000

# Distributed and CRPS Power Systems

Data Center Front End Power  
AC and DC Inputs Available  
450 to 3000 Watts



DS450DC

Voltage Availability				
Model	12 V	24 V	48 V	PMBus
	(-3)	(-5)	(-9)	
DS450	•			
DS450DC	•			
DS495SPE	•			
DS500SDC	•			
DS550	•			
DS550DC	•			
DS650	•	•	•	
DS650DC	•			
DS750PED	•			
DS760SL	•			
DS800SL	•			•
DS850	•	•	•	
DS850DC	•			
DS1100PED	•			
DS1100SDC	•			
DS1100SLPE	•			
DS1100TDC-3	•			
DS1200	•			•
DS1200DC	•			•
DS1600SPE	•			
DS2000	•			•
DS2000SPE	•			
DS2400SPE	•			
DS3000DC	•			
DS3000TE	•			

• Available

## SPECIAL FEATURES

- Active power factor correction
- EN61000-3-2 harmonic compliance
- Active AC inrush control
- High density
- Outputs +12 VDC with some +48 VDC models available
- 3.3 VDC standby
- 12.0 VDC standby on some models
- Options for 5 V standby voltage
- No minimum load required
- Hot plug operation
- N+1 redundant
- Internal OR-ing FETs
- Active current sharing
- Built-in cooling fans
- I<sup>2</sup>C Interface with EEPROM for FRU data
- Internal fan speed control with fan fail signal
- DC Input
- DSR1 rack for DS650/850. Ordering part number is 73-762-002. Standard 19" 1U fits up to 5 modules (4250 Watts)
- Options for reverse airflow
- Platinum Plus efficiency on some models

Safety	
UL	UL60950 (UL recognized)
NEMKO	EN60950
TÜV	EN60950
CE	Mark
CB	Report



Specifications				
	DS450-3	DS450DC-3	DS495SPE-3	DS500SDC-3
<b>Input</b>				
Input Range	90 to 264 VAC	40 to 72 VDC	90 to 264 VAC	-36 to -72 VDC
Frequency	47 to 63 Hz	DC	47 to 63 Hz	N/A
Efficiency	80% Typ	80% Typ	94% Typ Platinum	90% Typ
EMI/RFI	Class B	N/A	Class A	Class A
Leakage Current	1.4 mA @ 240 V	N/A	1.0 mA	N/A
<b>Outputs</b>				
Output Main	12 V / 37 A	12 V / 37 A	12 V / 41.2 A	12 V / 41.6 A
Output Stand-By	3.3 Vsb / 3 A	3.3 Vsb / 3 A	12 V / 3.0 A	12 V / 3.0 A
OCP/OVP/OTP	Yes	Yes	Yes	Yes
I <sup>2</sup> C Control	Yes	Yes	Yes	Yes
<b>Environmental</b>				
Operating Temp	-10 to 50°C	-10 to 50°C	0 to 50°C	0 to 50°C
Derating	N/A	N/A	N/A	N/A
Storage	-40 to +85°C	-40 to +85°C	-40 to 70°C	-40 to 70°C
RoHS Compliant	Yes	Yes	Yes	Yes
MTBF	300K Hours	500K Hours	> 900K Hours	> 500K Hours
<b>Other</b>				
Size (in)	1.57" x 3.07" x 11.05"	1.57" x 3.07" x 11.05"	1.57" x 3.39" x 7.73"	1.57" x 3.39" x 7.73"
Size (mm)	40 x 78 x 280	40 x 78 x 280	40 x 86.3 x 196.5	40 x 86.3 x 196.5
Power Density	8.42	8.42	12.2	12.2
Cubic Inches	53.42	53.42	41.14	41.14
Pro-E Files	No	Yes	Yes	Yes
Thermal Data	Yes	Yes	Yes	Yes
PQ Airflow Curves	Yes	Yes	Yes	Yes
Warranty	Two Years	Two Years	Two Years	Two Years
<b>Ordering Codes</b>				
Standard	DS450-3	DS450DC-3	DS495SPE-3	DS500SDC-3
ALT Standby	DS450-3-001			
Reverse Air	DS450-3-002	DS450DC-3-002	DS495SPE-3-001	DS500SDC-3-001



DS495SPE-3



DS500SDC-3

## DISTRIBUTED AND CRPS POWER

Specifications						
	DS550-3	DS550DC-3	DS650-3	DS650-5	DS650-9	DS650DC-3
<b>Input</b>						
Input Range	90 to 264 VAC	40 to 72 VDC	90 to 264 VAC	90 to 264 VAC	90 to 264 VAC	40 to 72 VDC
Frequency	47 to 63 Hz	DC	47 to 63 Hz	47 to 63 Hz	47 to 63 Hz	DC
Efficiency	80% Typ	80% Typ	80% Typ	80% Typ	82% Typ	80% Typ
EMI/RFI	Class B	N/A	Class B	Class B	Class B	N/A
Leakage Current	1.4 mA @ 240 V	N/A	1.4 mA @ 240 V	1.4 mA @ 240 V	1.4 mA @ 240 V	N/A
<b>Outputs</b>						
Output Main	12 V / 45 A	12 V / 45 A	12 V / 52.5 A	24 V / 26.3 A	48 V / 13.1 A	12 V / 52.5 A
Output Stand-By	3.3 Vsb / 3 A	3.3 Vsb / 3 A	3.3 Vsb / 6 A	3.3 Vsb / 6 A	3.3 Vsb / 6 A	3.3 Vsb / 6 A
OCV/OVP/OTP	Yes	Yes	Yes	Yes	Yes	Yes
I <sup>2</sup> C Control	Yes	Yes	Yes	Yes	Yes	Yes
<b>Environmental</b>						
Operating Temp	-10 to 50°C	-10 to 50°C	-10 to 50°C	-10 to 50°C	-10 to 50°C	-10 to 50°C
Derating	N/A	N/A	50% at 70°C	50% at 70°C	50% at 70°C	50% at 70°C
Storage	-40 to +85°C	-40 to +85°C	-40 to +85°C	-40 to +85°C	-40 to +85°C	-40 to +85°C
RoHS Compliant	Yes	Yes	Yes	Yes	Yes	Yes
MTBF	300K Hours	500K Hours	500K Hours	500K Hours	500K Hours	500K Hours
<b>Other</b>						
Size (in)	1.57" x 3.07" x 11.05"	1.57" x 3.07" x 11.05"	1.57" x 3.20" x 11.00"	1.57" x 3.20" x 11.00"	1.57" x 3.20" x 11.00"	1.57" x 3.20" x 11.00"
Size (mm)	40 x 78 x 280	40 x 78 x 280	40 x 81.3 x 279.4	40 x 81.3 x 279.4	40 x 81.3 x 279.4	40 x 81.3 x 279.4
Power Density	10.30	10.30	11.76	11.76	11.76	11.76
Cubic Inches	53.42	53.42	55.44	55.44	55.44	55.44
Pro-E Files	No	Yes	Yes	Yes	Yes	Yes
Thermal Data	Yes	Yes	Yes	Yes	Yes	Yes
PQ Airflow Curves	Yes	Yes	Yes	Yes	Yes	Yes
Warranty	Two Years	Two Years	Two Years	Two Years	Two Years	Two Years
<b>Ordering Codes</b>						
Standard	DS550-3	DS550DC-3	DS650-3	DS650-5	DS650-9	DS650DC-3
ALT Standby						DS650DC-3-002
Reverse Air		DS550DC-3-003	DS650-3-007			DS650DC-3-003
ALT Standby & Reverse Air						DS650DC-3-004
Disable External Fan Drive						



DS550DC-3



DS650-3

Specifications						
	DS750PED-3	DS760SL-3	DS800SL-3	DS850-3	DS850-5	DS850-9
<b>Input</b>						
Input Range	90 to 264 VAC	90 to 264 VAC	90 to 264 VAC	90 to 264 VAC	90 to 264 VAC	90 to 264 VAC
Frequency	47 to 63 Hz	47 to 63 Hz	47 to 63 Hz	47 to 63 Hz	47 to 63 Hz	47 to 63 Hz
Efficiency	94% Typ	90% Typ	92% Typ	82% Typ	82% Typ	83% Typ
EMI/RFI	Class A	Class A	Class B	Class B	Class B	Class B
Leakage Current	1.75 mA @ 240 V	0.8 mA @ 240 V	0.8 mA @ 240 V	1.4 mA @ 240 V	1.4 mA @ 240 V	1.4 mA @ 240 V
<b>Outputs</b>						
Output Main	12 V / 62.5 A	12 V / 62.3 A	12 V / 66.7 A	12 V / 70 A	24 V / 35 A	48 V / 17.5 A
Output Stand-By	12 V / 3 A	5.0 Vsb / 3.6 A	5.0 Vsb / 4 A	3.3 Vsb / 6 A	3.3 Vsb / 6 A	3.3 Vsb / 6 A
OCP/OVP/OTP	Yes	Yes	Yes	Yes	Yes	Yes
I <sup>2</sup> C Control	Yes	Yes	Yes	Yes	Yes	Yes
<b>Environmental</b>						
Operating Temp	0 to 50°C	0 to 50°C	0 to 50°C	-10 to 50°C	-10 to 50°C	-10 to 50°C
Derating	N/A	N/A	N/A	50% at 70°C	50% at 70°C	50% at 70°C
Storage	-40 to +70°C	-40 to +85°C	-40 to +85°C	-40 to +85°C	-40 to +85°C	-40 to +85°C
RoHS Compliant	Yes	Yes	Yes	Yes	Yes	Yes
MTBF	200K Hours	300K Hours	500K Hours	500K Hours	500K Hours	500K Hours
<b>Other</b>						
Size (in)	1.57" x 3.39" x 7.74"	1.57" x 2.15" x 12.68"	1.57" x 2.15" x 12.68"	1.57" x 3.20" x 11.00"	1.57" x 3.20" x 11.00"	1.57" x 3.20" x 11.00"
Size (mm)	41 x 86.3 x 196.5	40 x 54.5 x 322	40 x 54.5 x 322	40 x 81.3 x 279.4	40 x 81.3 x 279.4	40 x 81.3 x 279.4
Power Density	18.23	17.76	18.69	15.38	15.38	15.38
Cubic Inches	41.14	42.8	42.8	55.44	55.44	55.44
Pro-E Files	Yes	Yes	Yes	Yes	Yes	Yes
Thermal Data	Yes	Yes	Yes	Yes	Yes	Yes
PQ Airflow Curves	Yes	Yes	Yes	Yes	Yes	Yes
Warranty	Two Years	Two Years	Two Years	Two Years	Two Years	Two Years
<b>Ordering Codes</b>						
Standard	DS750PED-3	DS760SL-3	DS800SL-3	DS850-3	DS850-5	DS850-9
ALT Standby				DS850-3-005		
Reverse Air	DS750PED-3-001	DS760SL-3-001	DS800SL-3-001	DS850-3-006		
ALT Standby & Reverse Air		DS760SL-3-003				



## DISTRIBUTED AND CRPS POWER

Specifications					
	DS850DC-3	DS1100PED-3	DS1100SDC-3	DS1100SLPE-3	DS1100TDC-3
<b>Input</b>					
Input Range	40 to 72 VDC	90 to 264 VAC	-36 to -72 VDC	90 to 264 VAC	-40 to -72 VDC
Frequency	DC	47 to 63 Hz	N/A	47 to 63 Hz	N/A
Efficiency	80% Typ	94% Typ	90% Typ	94% Typ	90% Typ
EMI/RFI	N/A	Class A	Class A	Class A	Class A
Leakage Current	N/A	1.75 mA @ 240 V	N/A	1.75 mA	N/A
<b>Outputs</b>					
Output Main	12 V / 70 A	12 V / 91.67 A	12 V / 91.67 A	12 V / 90 A	12 V / 91.67 A
Output Stand-By	3.3 Vsb / 6 A	12 V / 3 A	12 V / 3 A	3.3 V / 3 A	3.3 V / 3 A
OCP/OVP/OTP	Yes	Yes	Yes	Yes	Yes
I <sup>2</sup> C Control	Yes	Yes	Yes	Yes	Yes
<b>Environmental</b>					
Operating Temp	-10 to 50°C	0 to 50°C	0 to 50°C	0 to 50°C	0 to 50°C
Derating	50% at 70°C	N/A	N/A	60% at 65°C	N/A
Storage	-40 to +85°C	-40 to +70°C	-40 to 70°C	-40 to +85°C	-40 to 70°C
RoHS Compliant	Yes	Yes	Yes	Yes	Yes
MTBF	500K Hours	200K Hours	> 200K Hours	300K Hours	> 300K Hours
<b>Other</b>					
Size (in)	1.57" x 3.20" x 11.00"	1.57" x 3.39" x 7.75"	1.57" x 3.39" x 7.75"	1.57" x 2.15" x 12.66"	1.57" x 2.14" x 12.67"
Size (mm)	40 x 81.3 x 279.4	42 x 86.3 x 196.5	42 x 86.3 x 196.5	40 x 54.6 x 321.56	40 x 54.5 x 322.0
Power Density	15.38	26.74	26.7	25.7	25.8
Cubic Inches	55.44	41.14	41.14	42.73	42.57
Pro-E Files	Yes	Yes	Yes	Yes	Yes
Thermal Data	Yes	Yes	Yes	Yes	Yes
PQ Airflow Curves	Yes	Yes	Yes	Yes	Yes
Warranty	Two Years	Two Years	Two Years	Two Years	Two Years
<b>Ordering Codes</b>					
Standard	DS850DC-3	DS1100PED-3	DS1100SDC-3	DS1100SLPE-3	DS1100TDC-3
ALT Standby	DS850DC-3-003				
Reverse Air	DS850DC-3-004	DS1100PED-3-001	DS1100SDC-3-001	DS1100SLPE-3-001	DS1100TDC-3-001
ALT Standby & Reverse Air					



DS850DC-3



DS1100PED-3



DS1100TDC-3

Specifications				
	DS1600SPE-3	DS2000-3	DS2000SPE-3	DS2400SPE-3
<b>Input</b>				
Input Range	180 to 264 VAC	90 to 264 VAC	90 to 140 VAC/180 to 264 VAC	90 to 140 VAC/180 to 264 VAC
Frequency	47 to 63 Hz	47 to 63 Hz	47 to 63 Hz	47 to 63 Hz
Efficiency	94% Typ	87% Typ	94% Typ Platinum	94% Typ Platinum
EMI/RFI	Class A	Class B	Class A	Class A
Leakage Current	1.75 mA @ 240 V	1.4 mA @ 240 V	0.75 mA	0.6 mA
<b>Outputs</b>				
Output Main	12 V / 133.3 A <sup>1</sup>	12 V / 165 A <sup>1</sup>	12 V / 163.9 A <sup>1</sup>	12.2 V / 196.7 A <sup>1</sup>
Output Stand-By	12 V / 4.5 A	3.3 Vsb / 9 A	12 V / 3.5 A	12 V / 3.5 A
OCP/OVP/OTP	Yes	Yes	Yes	Yes
I <sup>2</sup> C Control	Yes	Yes	Yes	Yes
<b>Environmental</b>				
Operating Temp	0 to 50°C	-10 to 50°C	0 to 50°C	0 to 50°C
Derating	70% at 60°C	N/A	N/A	70% at 60°C
Storage	-40 to +85°C	-40 to +85°C	-40 to 70°C	-40 to 70°C
RoHS Compliant	Yes	Yes	Yes	Yes
MTBF	200K Hours	500K Hours	> 500K Hours	500K Hours
<b>Other</b>				
Size (in)	1.57" x 3.39" x 7.76"	1.57" x 4.2" x 11.6"	1.57" x 3.39" x 7.75"	1.57" x 3.39" x 7.75"
Size (mm)	40 x 86.3 x 196.5	40 x 106.7 x 295.7	40 x 86.3 x 196.5	40 x 86.3 x 196.5
Power Density	38.89	26.2	48.6	58.2
Cubic Inches	41.14	76.5	41.14	41.14
Pro-E Files	Yes	Yes	Yes	Yes
Thermal Data	Yes	Yes	Yes	Yes
PQ Airflow Curves	Yes	Yes	Yes	Yes
Warranty	Two Years	Two Years	Two Years	Two Years
<b>Ordering Codes</b>				
Standard	DS1600SPE-3	DS2000-3	DS2000SPE-3	DS2400SPE-3
ALT Standby		DS2000-3-002		DS2400SPE-3-001
Reverse Air	DS1600SPE-3-001	DS2000-3-001	DS2000SPE-3-001	
ALT Standby & Reverse Air				

<sup>1</sup> Low line derating will apply



## DISTRIBUTED AND CRPS POWER

Specifications		
	DS3000DC-3	DS3000TE-3
<b>Input</b>		
Input Range	-40 to -72 VDC	208 to 264 VAC
Frequency	N/A	47 to 63 Hz
Efficiency	90% Typ	96% Typ Titanium
EMI/RFI	Class A	Class A
Leakage Current	N/A	0.75 mA
<b>Outputs</b>		
Output Main	12 V / 248 A	12 V / 250 A
Output Stand-By	12 V / 4.5 A	12 V / 4.5 A
OCP/OVP/OTP	Yes	Yes
I <sup>2</sup> C Control	Yes	Yes
<b>Environmental</b>		
Operating Temp	0 to 40°C	0 to 40°C
Derating		25% at 50°C
Storage	-40 to 70°C	-40 to 85°C
RoHS Compliant	Yes	Yes
MTBF	> 400K Hours	400K Hours
<b>Other</b>		
Size (in)	4.15" x 2.78" x 11.8"	4.15" x 2.78" x 11.12"
Size (mm)	105.5 x 70.6 x 299.7	105.5 x 70.6 x 282.6
Power Density	22.0	26.26
Cubic Inches	136	114.23
Pro-E Files	Yes	Yes
Thermal Data	Yes	Yes
PQ Airflow Curves	Yes	Yes
Warranty	Two Years	Two Years
<b>Ordering Codes</b>		
Standard	DS3000DC-3	DS3000TE-3
ALT Standby		
Reverse Air	DS3000DC-3-001	DS3000TE-3-001
ALT Standby & Reverse Air		



DS3000DC-3

Specifications						
	CSU550AP-3	CSU800AP-3	CSU1300AP-3	CSU1800AP-3	CSU2000AP-3	CSU2400AP-3
<b>Input</b>						
Input Range	90 to 264 VAC	90 to 264 VAC	90 to 264 VAC	90 to 264 VAC	90 to 264 VAC	90 to 264 VAC
Frequency	47 to 63 Hz	47 to 63 Hz	47 to 63 Hz	47 to 63 Hz	47 to 63 Hz	47 to 63 Hz
Efficiency	94% Typ Platinum	94% Typ Platinum	94% Typ Platinum	94% Typ Platinum	94% Typ Platinum	94% Typ Platinum
EMI/RFI	Class A	Class A	Class A	Class A	Class A	Class A
Leakge Current	0.85 mA	1.75 mA	1.75 mA	0.6 mA	0.6 mA	0.6 mA
<b>Outputs</b>						
Output Main	12 V / 45.0 A	12 V / 66.7 A	12.2 V / 108.3 A	12.2 V / 147.5 A	12.2 V / 163.9 A <sup>1</sup>	12.2 V / 196.7 A
Output Stand-by	12 V / 2.5 A	12 V / 2.5 A	12 V / 3.5 A	12 V / 3.5 A	12 V / 3.5 A	12 V / 3.5 A
OCV/OVP/OTP	Yes	Yes	Yes	Yes	Yes	Yes
I <sup>2</sup> C Control	Yes	Yes	Yes	Yes	Yes	Yes
<b>Environmental</b>						
Operating Temp	0 to 50°C	0 to 50°C	0 to 55°C	0 to 55°C	0 to 55°C	0 to 55°C
Derating						
Storage	-40 to 70°C	-40 to 70°C	-40 to 70°C	-40 to 70°C	-40 to 60°C	-40 to 70°C
RoHS Compliant	Yes	Yes	Yes	Yes	Yes	Yes
MTBF	> 250K Hours	> 250K Hours	> 250K Hours	> 250K Hours	> 250K Hours	> 250K Hours
<b>Other</b>						
Size (in)	1.57" x 2.89" x 7.28"	1.57" x 2.89" x 7.28"	1.57" x 2.89" x 7.28"	1.57" x 2.89" x 7.28"	1.57" x 2.89" x 7.28"	1.57" x 2.89" x 7.28"
Size (mm)	40 x 73.5 x 185	40 x 73.5 x 185	40 x 73.5 x 185	40 x 73.5 x 185	40 x 73.5 x 185	40 x 73.5 x 185
Power Density	16.7	16.7	40.6	56	62.6	75
Cubic Inches	33	33	33	33	33	33
Pro-E files	Yes	Yes	Yes	Yes	Yes	Yes
Thermal Data	Yes	Yes	Yes	Yes	Yes	Yes
PQ Airflow Curves	Yes	Yes	Yes	Yes	Yes	Yes
Warranty	Two years	Two years	Two years	Two years	Two years	Two years
<b>Ordering Codes</b>						
Standard	CSU550AP-3	CSU800AP-3	CSU1300AP-3	CSU1800AP-3-100	CSU2000AP-3-100 <sup>2</sup> CSU2000AP-3-200 <sup>3</sup>	CSU2400AP-3-100
ALT Standby						
Reverse Air	CSU550AP-3-001	CSU800AP-3-001	CSU1300AP-3-001	CSU1800AP-3-111	CSU2000AP-3-111 <sup>2</sup> CSU2000AP-3-211 <sup>3</sup>	CSU2400AP-3-111
ALT Standby & Reverse Air						

<sup>1</sup> Low line derating will apply  
<sup>2</sup> IEC C14 AC inlet  
<sup>3</sup> IEC C20 AC inlet



CSU800AP-3



CSU2000AP-3



CSU2400AP-3

## DISTRIBUTED AND CRPS POWER

Specifications			
	CSU800ADC-3	CSU1300ADC-3	CSU2000ADC-3
<b>Inputs</b>			
Input Range	-40 to -72 VDC	-40 to -72 VDC	-40 to -72 VDC
Frequency	N/A	N/A	N/A
Efficiency	>90% Typ	>90% Typ	94% Typ
EMI/RFI	Class A	Class A	Class A
Leakage Current	N/A	N/A	N/A
<b>Outputs</b>			
Output Main	12.2 V / 65.5 A	12.2 V / 106.5 A	12.2 V / 163.9 A
Output Stand-by	12 V / 3.5 A	12 V / 3.5 A	12 V / 3.5 A
OCP/OVP/OTP	Yes	Yes	Yes
I <sup>2</sup> C Control	Yes	Yes	Yes
<b>Environmental</b>			
Operating Temp	-5 to 55°C	-5 to 55°C	-5 to 55°C
Derating			
Storage	-40 to 70°C	-40 to 70°C	-40 to 70°C
RoHS Compliant	Yes	Yes	Yes
MTBF	>250K Hours	>250K Hours	>250K Hours
<b>Other</b>			
Size (inch)	1.57" x 2.89" x 7.28"	1.57" x 2.89" x 7.29"	1.57" x 2.89" x 7.30"
Size (mm)	40 x 73.5 x 185	41 x 73.5 x 185	42 x 73.5 x 185
Power Density	16.7	40.6	62.6
Cubic Inches	33	33	33
Pro-E Files	Yes	Yes	Yes
Thermal Data	Yes	Yes	Yes
PQ Airflow Curves	Yes	Yes	Yes
Warranty	Two years	Two years	Two years
<b>Ordering codes</b>			
Standard	CSU800ADC-3-100	CSU1300ADC-3-100	CSU2000ADC-3-100
Alt Standby			
Reverse Air	TBD	TBD	CSU2000ADC-3-101
ALT Standby & Reverse Air			



CSU2000ADC-3



Specifications				
	CSV1100BP-3	CSV1300BP-3	CSV1600BP-3	CSV2000BP-3
<b>Input</b>				
Input Range	90 to 264 VAC	90 to 264 VAC	180 to 264 VAC	180 to 264 VAC
Frequency	47 to 63 Hz	47 to 63 Hz	47 to 63 Hz	47 to 63 Hz
Efficiency	94% Typ Platinum	94% Typ Platinum	94% Typ Platinum	94% Typ Platinum
EMI/RFI	Class A	Class A	Class A	Class A
Leakge Current	< 3.45 mA	< 3.45 mA	< 3.45 mA	< 3.45 mA
<b>Outputs</b>				
Output Main	12.2 V / 90.1 A	12 V / 106.6 A	12.2 V / 131.1 A	12.2 V / 163.9 A
Output Stand-by	12 V / 2.5 A	12 V / 3.0 A	12 V / 2.5 A	12 V / 2.5 A
OCP/OVP/OTP	Yes	Yes	Yes	Yes
I <sup>2</sup> C Control	Yes	Yes	Yes	Yes
<b>Environmental</b>				
Operating Temp	0 to 50°C	0 to 50°C	0 to 50°C	0 to 50°C
Derating				
Storage	-40 to 70°C	-40 to 60°C	-40 to 70°C	-40 to 70°C
RoHS Compliant	Yes	Yes	Yes	Yes
MTBF	> 500K Hours	> 500K Hours	> 500K Hours	> 500K Hours
<b>Other</b>				
Size (inch)	1.57" x 3.15" x 7.73"	1.57" x 3.15" x 7.73"	1.57" x 3.15" x 7.73"	1.57" x 3.15" x 7.73"
Size (mm)	40 x 80 x 195	40 x 80 x 195	40 x 80 x 195	40 x 80 x 195
Power Density	28.8	34.0	41.8	52.3
Cubic Inches	38.22	38.22	38.22	38.22
Pro-E files	Yes	Yes	Yes	Yes
Thermal Data	Yes	Yes	Yes	Yes
PQ Airflow Curves	Yes	Yes	Yes	Yes
Warranty	Two years	Two years	Two years	Two years
<b>Ordering Codes</b>				
Standard	700-014189-1400	700-013496-J100	700-014190-1000	700-014265-1000
ALT Standby				
Reverse Air				
ALT Standby & Reverse Air				



# PS1000 and PL1000

High Availability Power Supply Units  
1000 Watts



## SPECIAL FEATURES

- Fault mode resiliency
- Dynamic maximum input power limit (DMIPL)
- AC feed failure, automatic switchover
- Inrush current control
- N+1 internal redundant
- PMBus® compliant

### Total Power

1000 W

### Output

12.25 V

### Safety

- UL/CSA 60950 (UL recognized)
- IEC 60950
- CE Mark

## Electrical Specifications

### PS1000

Output Power	1000 W total
Redundancy	680 W N+1 (3 x 340 W PSU modules in parallel)
Output Voltage	12.25 VDC
Phases	Dual three-phase AC input with input voltage selector (IVS)
Efficiency	>92% at full load
Input Voltage	Three-phase 415/400 VAC Wye or 208 VAC Delta or Single-phase 200 to 240 VAC
Operating Temp	10 to 48°C

### PL1000

BBU	Embedded 8-cell, 32 V pack battery backup unit		
BBU Specification	The battery shall operate for up to 1.0 second at 680 W. Then after that the PSU shall be capable to output 105 kJ between 100 W and 300 W. Typical run times are shown below:		
	Power Level (W)	Runtime (s)	Energy (kJ)
	100	1050	105
	150	700	105
	200	525	105
	250	420	105
	300	350	105
Operating Temp	10 to 48°C		

Compliance
EMC Conducted/Radiated Class A
EMC EN/IEC 61000
RoHS

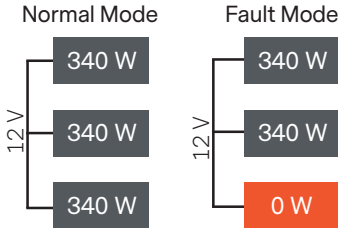

**PRODUCT PHOTOS**

Front view



Rear view



Ordering Information		
Model Number	Main Output	With Batteries
PL1000	12.25 V	Y
PS1000	12.25 V	N



# PS1650

High Availability Power Supply Unit  
1650 Watts

## SPECIAL FEATURES

- Fault mode resiliency
- Dynamic maximum input power limit (DMIPL)
- Inrush current control
- N+1 internal and external redundancy, up to four (4) PSUs in a system
- PMBus™ compliant
- Hot pluggable

### Total Power

1650 W

### Output

12.25 V

### Safety

- UL/CSA 60950 (UL recognized)
- IEC 60950
- CE Mark

## Electrical Specifications

### PS1650

Output Power	1650 W total
Redundancy	1100 W N+1 (3 x 550 W PSU modules in parallel) internal and external redundancy, supports up to four (4) PSUs in a system
Output Voltage	12.25 VDC
Efficiency	91%
Input Voltage	Three-phase 415/400 VAC Wye or 208 VAC Delta or Single-phase 200 to 240 VAC
PSU Operating Temperature	10 to 45°C

## Compliance

EMC Conducted/Radiated Class A
EMC EN/IEC 61000
RoHS

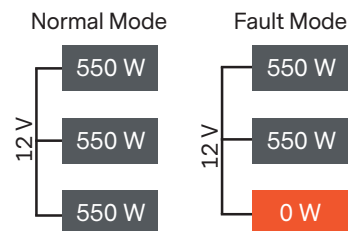

PRODUCT PHOTOS

Front view



Rear view



Ordering Information	
Model Number	Main Output
PS1650	12.25 V



# 50 V, 18 kW, 1U Open Rack Power Shelf

## 15 kW N+1

### SPECIAL FEATURES

- 15000 W at 50 V with active current share
- Houses 6 x 3000 W power modules and a removable shelf controller
- Very high efficiency
- Accepts 3 types of input configurations (3P Delta 4 W, 3P Wye 5 W, 3x of 1P)

### Total Output Power

18 kW

### Safety

- UL 60950
- IEC 60950
- EN 62368-1
- EN 62368-1
- IEC 62368-1

### Electrical Specifications

	MIN	NOM	MAX
<b>Input</b>			
Voltage (3 phase Delta 4 wire) VAC	180	200/277	305
Voltage (3 phase Wye 5 wire) VAC	360	380/480	528
Voltage (3x of 1 phase ) VAC	180	200/277	305
<b>Output</b>			
Set Point VDC ( 50% Load )	49.875	50	50.125
Battery Testing Voltage		48	
Current A	0	300	312
Ripple & Noise (@ 20MHz BW) mVpp			500
Output Excursion (from nominal voltage) During Transient Loading $V^{1,2,3}$	-1		+1

### Compliance

EN 61000-4-2 Cat-A for surges
EN 61000-3-2 Class-A for harmonics
EN55022, FCC Part 15, CISPR 22, Class-A for EMC

### Ordering Information

Model	Input	Output	Type
700-015234-0000	1 Phase AC, 180-305 V, 50-60 Hz	50 V  60 A	ACDC-ORV3-3000W
700-015214-0000	3 Phase AC, 200/480 V, 50-60 Hz	50 V  300 A	ACDC-ORV3-1U-18kW
700-015219-0000	3 Phase AC, 200/480 V, 50-60 Hz	50 V  660 A	ACDC-ORV3-2U-36kW

- <sup>1</sup> Max Current Step: 10% to 50%, 50% to 10%
- <sup>2</sup> Dynamic Load: 50Hz / 50% Duty
- <sup>3</sup> Slew Rate: 1A/uS



# 50 V, 36 kW, 2U Open Rack Power Shelf

## 33kW N+1 or 18kW N+N

### SPECIAL FEATURES

- 36000 W at 50 V with active current share
- Houses 12 x 3000 W power modules and a removable shelf controller
- Very high efficiency
- Accepts 3 types of input configurations (3P Delta 4 W, 3P Wye 5 W, 3x of 1P)

### Total Output Power

36 kW

### Safety

- UL 60950
- IEC 60950
- EN 62368-1
- UL 62368-1
- IEC 62368-1

### Electrical Specifications

	MIN	NOM	MAX
<b>Input</b>			
Voltage (3 phase Delta 4 Wire) VAC	180	200/277	305
Voltage (3 phase Wye 5 Wire) VAC	360	380/480	528
Voltage (3x of 1 phase) VAC	180	200/277	305
<b>Output</b>			
Set Point VDC ( 50% Load )	49.875	50	50.125
Battery Testing Voltage		48	
Current A	0	660	690
Ripple & Noise (@ 20MHz BW) mVpp			500
Output Excursion (from Nominal voltage) During Transient Loading V <sup>1,2,3</sup>	-1		+1



### Compliance

EN 61000-4-2 Cat-A for surges

EN 61000-3-2 Class-A for harmonics

EN55022, FCC Part 15, CISPR 22, Class-A for EMC

### Ordering Information

Model	Input	Output	Type
700-015234-0000	1 Phase AC, 180 to 305 V, 50 to 60 Hz	50 V  60 A	ACDC-ORV3-3000W
700-015214-0000	3 Phase AC, 200/480 V, 50 to 60 Hz	50 V  300 A	ACDC-ORV3-1U-18kW
700-015219-0000	3 Phase AC, 200/480 V, 50 to 60 Hz	50 V  660 A	ACDC-ORV3-2U-36kW

<sup>1</sup> Max Current Step: 10% to 50%, 50% to 10%

<sup>2</sup> Dynamic Load: 50Hz / 50% Duty

<sup>3</sup> Slew Rate: 1A/uS



# 50 V, 3 kW, Open Rack Rectifier

## For 18 kW & 36 kW Open Rack V3 Power Shelves

### SPECIAL FEATURES

- Greater than 96.5% efficiency from 240 to 277 V AC input with 30-100% load (peak efficiency of 97.5%)
- 200 to 277 VAC input
- Active current sharing
- OCP compliant
- Hot pluggable PSUs
- Status LEDs for fault monitoring
- 48 V fixed on battery test operation

### Total Output Power

3 kW

### Safety

- UL 60950
- IEC 60950
- IEC 62368-1
- UL62368-1
- EN62368-1

### Electrical Specifications

	MIN	NOM	MAX
<b>Input</b>			
Voltage VAC	180	200/277	305
Hold up (@100% Load 200 to 277 VAC) msec		20	
iTHD (Load >30%) %			5
Power Factor (10 to 30% loading) %	95		
Power Factor (30 to 100% loading) %	97		
Power Factor (above 50% loading) %	98		
<b>Output</b>			
Set Point VDC (50% Load)	49.875	50	50.125
Battery Testing Voltage (V)		48	
Current A	0		62
Ripple & Noise (@ 20MHz BW) mVpp			500
Output Excursion (from nominal voltage) During Transient Loading mV <sup>1, 2, 3</sup>	-1		+1

### Compliance

ICE EN 61000-4-2 Cat-A for surges  
 EN 61000-3-2 Class-A for harmonics  
 CISPR and FCC Part A for EMC

### Ordering Information

Model	Input	Output	Type
700-015234-0000	1 Phase AC, 180 to 305 V, 50 to 60 Hz	50 V  60 A	ACDC-ORV3-3000W
700-015214-0000	3 Phase AC, 200/480 V, 50 to 60 Hz	50 V  300 A	ACDC-ORV3-1U-18kW
700-015219-0000	3 Phase AC, 200/480 V, 50 to 60 Hz	50 V  660 A	ACDC-ORV3-2U-36kW

- <sup>1</sup> Max Current Step: 10% to 50%, 50% to 10%
- <sup>2</sup> Dynamic Load: @20 Hz
- <sup>3</sup> Slew Rate: 1A/uSEC



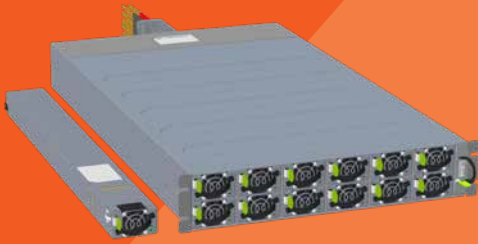

# 48 V, 36 kW, 2U Open Rack Power Shelf

## 36 kW N+1 or 18 kW N+N

### SPECIAL FEATURES

- 36 kW at 48 V with active current share
- Houses 36 kW power modules and a removable shelf controller
- Designed for dual AC feeds, Automatic Transfer Switch (ATS) PSUs
- Very high efficiency
- Accepts 3 types of input configurations (3P Delta 4 W, 3P Wye 5 W, 3x of 1P)

### Total Output Power

36 kW

### Safety

- EN 62368-1
- UL 62368-1
- IEC 62368-1

Electrical Specifications			
	MIN	NOM	MAX
<b>Input</b>			
Voltage (3 phase Delta 4 Wire) VAC	180	200/277	305
Voltage (3 phase Wye 5 Wire) VAC	360	380/480	528
Voltage (3x of 1 phase) VAC	180	200/277	305
<b>Output</b>			
Set Point VDC (20% load)	49.65 V	49.7 V	49.75 V
Droop (0~100% load)		-1.5 V	
Current A	0	660	690
Ripple & Noise (@ 20MHz BW) mVpp			500
Output Excursion (from Nominal voltage) During Transient Loading V <sup>1,2,3</sup>	-1		+1

Compliance
EN61000-4-5 Level 3 for AC Mains Surge
EN55035

Ordering Information			
Model # for Shelf Still Tbd			
Model	Input	Output	Type
700-015234-0000	1 Phase AC, 180 to 305 V, 50 to 60 Hz	50 V  60 A	ACDC-ORV3-3000W
700-015214-0000	3 Phase AC, 200/480 V, 50 to 60 Hz	50 V  300 A	ACDC-ORV3-1U-18kW
700-015219-0000	3 Phase AC, 200/480 V, 50 to 60 Hz	50 V  660 A	ACDC-ORV3-2U-36kW

<sup>1</sup> Max Current Step: 10% to 60%, 50% to 10%  
<sup>2</sup> Dynamic Load: 50Hz / 50% Duty  
<sup>3</sup> Slew Rate: 1A/uS

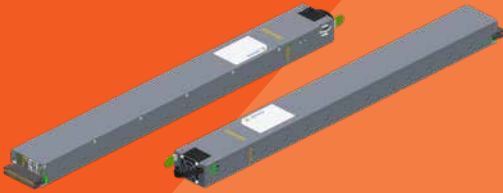

# 48 V, 3 kW, Open Rack Rectifier with ATS

For 18 kW & 36 kW 2RU, 19" or 21" Power Shelves

## SPECIAL FEATURES

- Greater than 96% efficiency from 240 to 277 V AC input with 30 to 100% load (peak efficiency of 97%)
- Automatic Transfer Switch (ATS) built in
- 68 mm wide
- I<sup>2</sup>C
- > 24 msec hold up
- 200 to 277 VAC input
- Active current sharing
- OCP compliant
- Hot pluggable PSUs
- Status LEDs for fault monitoring
- 36 kW total, 33 kW N +1, or 18 kW N + N

### Total Output Power

3 kW

### Safety

- IEC 62368-1
- UL62368-1
- EN62368-1

Electrical Specifications			
	MIN	NOM	MAX
<b>Input</b>			
Voltage VAC	180	200/277	305
Hold up (@100% Load 200 to 277 VAC) msec		25	
iTHD (Load >30%) %			5
Power Factor 10% and Above	95		
<b>Output</b>			
Set Point VDC (20% Load)	49.65 V	49.7 V	49.75 V
Droop (0~100% load)		-1.5 V	
Current A	0		62
Ripple & Noise (@ 20MHz BW) mVpp			500
Output Excursion (from Nominal voltage) During Transient Loading V <sup>1,2,3</sup>	-1		+1

Compliance
EN61000-4-5 Level 3 for AC Mains Surge
EN55035

Ordering Information			
Model	Input	Output	Type
700-015234-0000	1 Phase AC, 180 to 305 V, 50 to 60 Hz	50 V  60 A	ACDC-ORV3-3000W
700-015214-0000	3 Phase AC, 200/480 V, 50 to 60 Hz	50 V  300 A	ACDC-ORV3-1U-18kW
700-015219-0000	3 Phase AC, 200/480 V, 50 to 60 Hz	50 V  660 A	ACDC-ORV3-2U-36kW

- <sup>1</sup> Max Current Step: 10% to 60%, 50% to 100%
- <sup>2</sup> Dynamic Load: @50Hz to 10kHz
- <sup>3</sup> Slew Rate: 1A/uSEC

# ADN-C Series Single Phase

## 120 to 960 Watts

### SPECIAL FEATURES

- Slim form factor
- Five year warranty
- High efficiency > 90% typical
- Full power at 60°C
- PowerBoost technology
- Industrial grade design
  - Metal mounting clip
  - Metal case
- MTBF > 450,000h demonstrated at 40°C
- Active PFC > 0.92
- Adjustable output
- Over-voltage protection with auto recovery
- Continuous short-circuit and over-load protection
- SEMI F47 Sag Immunity
- New visual diagnostic LED
- Three Status LEDs
  - Input, Output, Alarm
- DC OK Relay
- Parallel operation capability
- Screw terminal connections
- RoHS compliant
- No tools required for mounting



Electrical Specifications	
Input	
AC Input Range	Nominal: 115 to 230 VAC 85 to 264 VAC
DC Input Range	90 to 375 VDC
Frequency	47 to 67 Hz
Efficiency	> 90%
Inrush Current	ADN5-24-1PM-C: < 15 A ADN10-24-1PM-C: < 30 A ADN20-24-1PM-C: < 40 A
PFC	Active, better than 0.92

Electrical Specifications	
Output	
Nominal Voltage	ADN5-24-1PM-C & ADN10-24-1PM-C: 24 VDC (22.5 to 28.5 VDC Adj) ADN20-24-1PM-C: 24 VDC (24 to 28 VDC Adj)
Initial Voltage Setting	24.5 V $\pm$ 1%
Hold-up Time	> 20 ms @ full load (100 VAC Input @ $T_{amb} = +25^{\circ}\text{C}$ )
Voltage Regulation	< $\pm$ 2% (combination line, load, time and temperature related changes)
Ripple	ADN5-24-1PM-C & ADN10-24-1PM-C: < 50 mVpp ADN20-24-1PM-C: < 100 mVpp
Back EMF Immunity	< 35 VDC
PowerBoost	1.5x Nominal current for 4 seconds
Short-circuit Current	1.5x Nominal current @ near zero volts at short-circuit condition
Parallel Operation	Switch selectable single unit or parallel unit operation. Units will Not be damaged by parallel operation (regardless of switch position setting)
Output Noise Suppression	Radiated EMI values below EN61000-6-2
Over-Voltage Protection	> 30.5 VDC but < 33 VDC, auto recovery
Line and Load Regulation	< 0.5%
Time and Temperature Drift	< 1%

Ordering Information						
Power	Voltage		Current	Size L x W x H		Model Number
	VAC	VDC		in	mm	
120 W	85 to 264 VAC	90 to 375 VDC	5 A	4.85" x 1.97" x 4.37"	123 x 50 x 111	ADN5-24-1PM-C
240 W	85 to 264 VAC	90 to 375 VDC	10 A	4.85" x 2.36" x 4.37"	123 x 60 x 111	ADN10-24-1PM-C
480 W	85 to 264 VAC	90 to 375 VDC	20 A	4.85" x 3.42" x 4.96"	123 x 87 x 126	ADN20-24-1PM-C
960 W	85 to 264 VAC	90 to 375 VDC	40 A	4.81" x 7.09" x 4.85"	122.2 x 180 x 123.3	ADN40-24-1PM-C

## DIN RAIL

# ADN-C Series 3-Phase

120 to 960 Watts



## SPECIAL FEATURES

- Slim form factor
- Five year warranty
- High efficiency > 93% typical
- Full power at 60°C
- PowerBoost technology
- Industrial grade design – metal cases
- MTBF > 450,000h demonstrated at 40°C
- Active PFC
- Adjustable output
- Over-voltage protection with auto recovery
- Continuous short-circuit and over-load protection
- Three Status LEDs – Input, Output, Alarm
- DC OK Relay
- Parallel operation capability
- Screw terminal connections
- RoHS compliant
- No tools required for mounting

Electrical Specifications	
<b>Input</b>	
Nominal Voltage	380 to 480 VAC
AC Input Range	320 to 540 VAC
DC Input Range	450 to 720 VDC for ADN20
Frequency	50 to 60 Hz
Efficiency	93% for ADN20; 94% for ADN40
PFC	Active power factor correction
Two Phase Input	Derate to 75% and 50% for ADN20 and ADN40 respectively under loss of 1 phase. Units will shut down if thermal threshold is exceeded under this condition
<b>Output</b>	
Nominal Voltage	24 V (24.0 to 28.0 VDC Adj.)
Hold-up Time	> 20 ms for ADN20; > 15 ms for ADN40
Voltage Regulation	< ±2% overall
Ripple	< 100 mVpp
PowerBoost	1.5x Nominal current for 4 seconds
Peak Current	1.5x Nominal current for 4 seconds minimum while holding voltage > 20 VDC
Parallel Operation	Single or parallel operation selectable via front switch. For redundant operation use of external diode module is preferred; ADN40 uses active paralleling
Power Back Immunity	> 35 V
Over-voltage Protection	> 30.5 VDC but < 33 VDC, auto recovery

Ordering Information						
Power	Voltage		Current	Size L x W x H		Model Number
	VAC	VDC		in	mm	
<b>120 W</b>	320 to 540 VAC	450 to 760 VDC	5 A @ 24 VDC	4.85" x 1.97" x 4.37"	123 x 50 x 111	ADN5-24-3PM-C
<b>240 W</b>	320 to 540 VAC	450 to 760 VDC	10 A @ 24 VDC	4.85" x 2.36" x 4.37"	123 x 60 x 111	ADN10-24-3PM-C
<b>480 W</b>	320 to 540 VAC	450 to 760 VDC	20 A @ 24 VDC	4.68" x 3.34" x 4.85"	119 x 85 x 123	ADN20-24-3PM-C
<b>960 W</b>	320 to 540 VAC	90 to 375 VDC	40 A @ 24 VDC	4.85" x 7.09" x 4.85"	123 x 180 x 123	ADN40-24-3PM-C



# DC-DC Converters

Advanced Energy is widely acknowledged as an industry leader in distributed power applications and produces an exceptionally wide range of DC-DC conversion products.

# Distributed Power Architecture

Advanced Energy understands the needs and nuances of developing power systems using distributed power architecture. We know it is your job to create the most efficient, cost-effective, quality system, and deliver it in a timely fashion.

From full-system power to board-level components, high-power isolated front ends to a full line of isolated and non-isolated DC-DC modules, Advanced Energy is the source for today's power systems.

## Distributed Power Architecture DC-DC Conversion

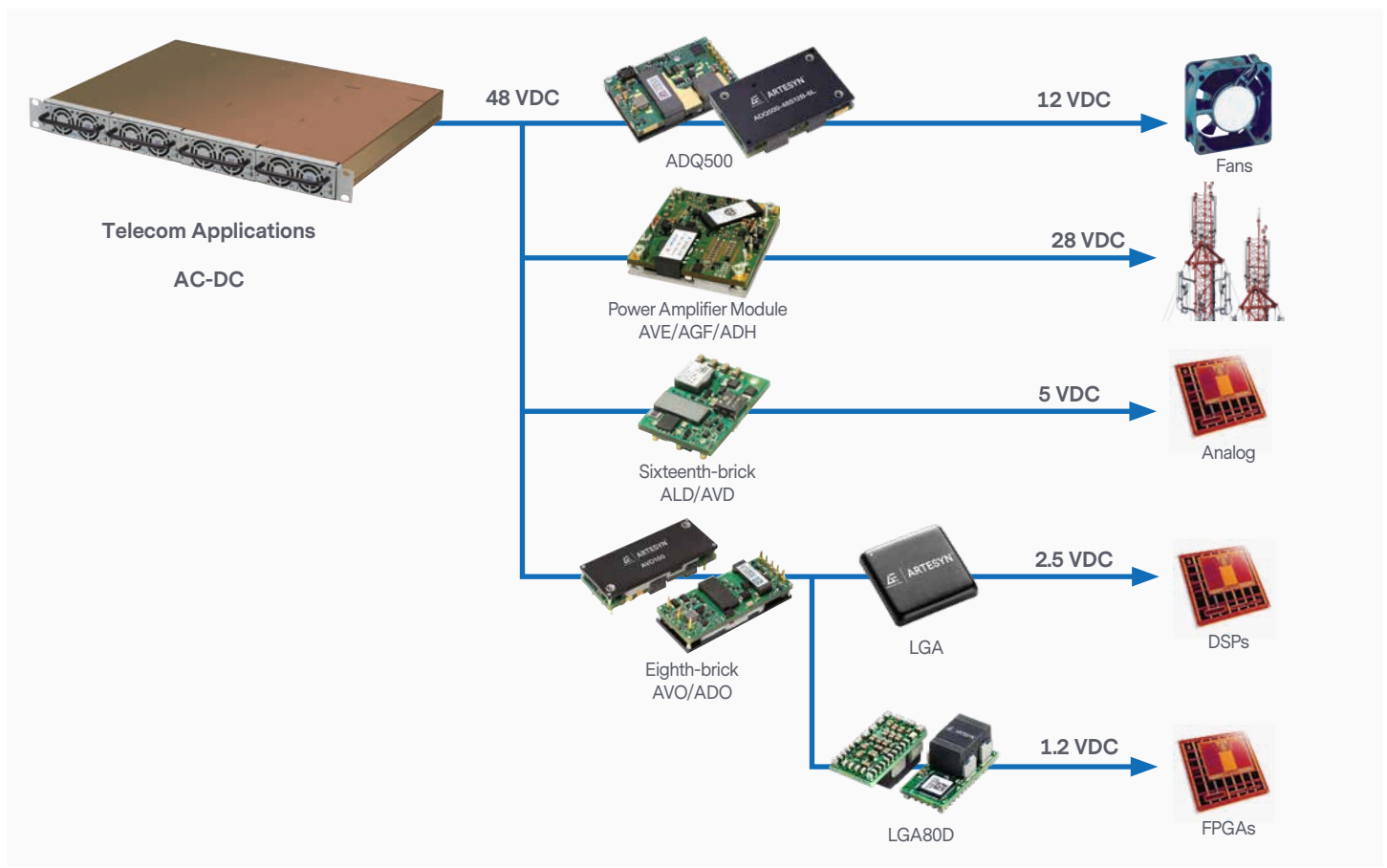
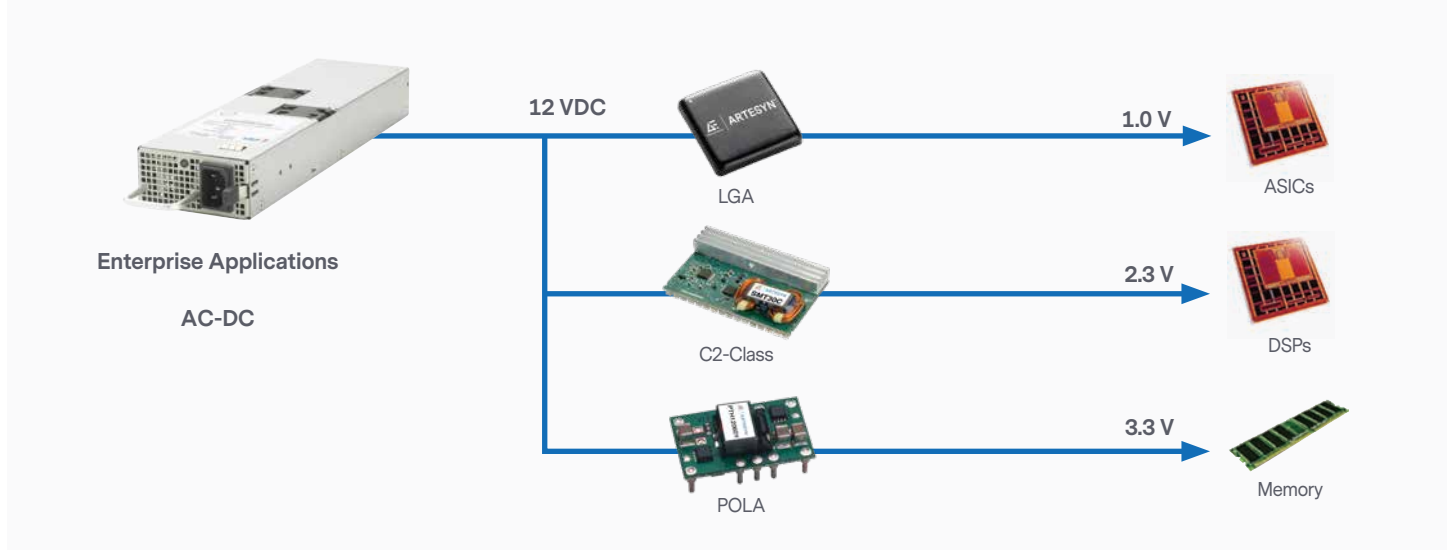

# Quarter-Brick



BDQ1300

## SPECIAL FEATURES

- Industry leading quarter-brick standard package and feature sets
- Up to 100 A offering
- Wide operating temperature range
- Meets basic insulation
- PMBus™ interface
- Exceptional dynamic response and reactive loading capability
- Monotonic start-up characteristic
- International safety standards approvals – UL, CSA, TÜV

Ordering Information					
Vout	Iout	Input Voltage	Package L x W x H (mm)	Efficiency	Model Number
3.3 V	<b>Open-frame</b>				
	40 A	48 V (36 to 75 V)	2.28" x 1.45" x 0.39" (57.9 x 36.8 x 9.8)	91%	AGQ200B-48S3V3-4L
	<b>Baseplate</b>				
	40 A	48 V (36 to 75 V)	2.28" x 1.45" x 0.50" (57.9 x 36.8 x 12.7)	91%	AGQ200B-48S3V3B-4L
5 V	<b>Open-frame</b>				
	20 A	24 V (18 to 36 V)	2.28" x 1.45" x 0.39" (57.9 x 36.8 x 9.8)	91%	AVQ100-24S05-4L
	<b>Baseplate</b>				
	20 A	24 V (18 to 36 V)	2.28" x 1.45" x 0.50" (57.9 x 36.8 x 12.7)	91%	AVQ100-24S05B-4L
10 V	<b>Open-frame</b>				
	60 A	48 V (40 to 60 V)	2.28" x 1.45" x 0.43" (57.9 x 36.8 x 11)	95%	ADQ600-48S10-6L
	<b>Baseplate</b>				
	60 A	48 V (40 to 60 V)	2.28" x 1.45" x 0.52" (57.9 x 36.8 x 13.3)	95%	ADQ600-48S10B-6L
12 V	<b>Open-frame</b>				
	25 A	48 V (36 to 75 V)	2.28" x 1.45" x 0.36" (57.9 x 36.8 x 9.6)	94%	AVQ300-48S12-6L
	33 A	48 V (36 to 75 V)	2.28" x 1.45" x 0.36" (57.9 x 36.8 x 9.6)	93%	AVQ400-48S12-6L
	42 A	48 V (36 to 75 V)	2.28" x 1.45" x 0.43" (57.9 x 36.8 x 11)	95%	ADQ500-48S12-6L
	50 A	48 V (40 to 60 V)	2.28" x 1.45" x 0.43" (57.9 x 36.8 x 11)	95%	ADQ600-48S12-6L
	58 A	48 V (40 to 60 V)	2.3" x 1.4" x 0.43" (58.4 x 36.8 x 11)	96%	ADQ700-48S12-4L
	58 A	48 V (40 to 60 V)	2.3" x 1.4" x 0.43" (58.4 x 36.8 x 11)	96%	ADQ700-48S12-4LI
	<b>Baseplate</b>				
	25 A	48 V (36 to 75 V)	2.28" x 1.45" x 0.50" (57.9 x 36.8 x 12.7)	94%	AVQ300-48S12B-4L
	33 A	48 V (36 to 75 V)	2.28" x 1.45" x 0.50" (57.9 x 36.8 x 12.7)	93%	AVQ400-48S12B-6L
	42 A	48 V (36 to 75 V)	2.28" x 1.45" x 0.43" (57.9 x 36.8 x 11)	95%	ADQ500-48S12B-6L
	50 A	48 V (40 to 60 V)	2.28" x 1.45" x 0.52" (57.9 x 36.8 x 13.3)	95%	ADQ600-48S12B-6L
	50 A	48 V (36 to 75 V)	2.28" x 1.45" x 0.43" (57.9 x 36.8 x 11)	95.5%	ADQ600B-48S12B-6L/K
	58 A	48 V (40 to 60 V)	2.3" x 1.4" x 0.52" (58.4 x 36.8 x 13.6)	96%	ADQ700-48S12B-4L
	58 A	48 V (40 to 60 V)	2.3" x 1.4" x 0.52" (58.4 x 36.8 x 13.6)	96%	ADQ700-48S12B-4LI
70 A	48 V (40 to 60 V)	2.3" x 1.4" x 0.53" (58.4 x 36.8 x 13.6)	96%	ADQ800-48S12B-4L	
90 A	48 V (40 to 60 V)	2.3" x 1.4" x 0.57" (58.4 x 36.8 x 14.5)	97.7%	BCQ1300-48S12B-4L	
90 A	48 V (40 to 60 V)	2.3" x 1.4" x 0.57" (58.4 x 36.8 x 14.5)	97.5%	BDQ1300-48S12B-4L	
90 A	48 V (40 to 60 V)	2.3" x 1.4" x 0.57" (58.4 x 36.8 x 14.5)	97.5%	BDQ1300-48S12B-4LI	

# Eighth-Brick

## SPECIAL FEATURES

- Industry leading eighth-brick standard package and feature sets
- Scalable output power offering: Low power 80 W series or up to 300 W high power series
- Mechanical options for optimum mounting flexibility: Open-frame (ALO, LES, AVO) or baseplate (AEO or AVO-B) construction; Through-hole (default) or surface mount (suffix “-S”) termination; 5 mm (default) or 3.7 mm through-hole pin length option
- PMBus™ interface
- Meets basic insulation
- Power densities as high as 181 W per in<sup>3</sup>
- Wide operating temperature range
- International safety standards approvals – UL, CSA, TÜV



Ordering Information					
Vout	Iout	Input Voltage	Package L x W x H (mm)	Efficiency	Model Number
1.2 V	<b>Open-frame</b>				
	20 A	48 V (36 to 75 V)	2.3" x 0.9" x 0.38" (57.9 x 22.9 x 9.6)	86%	AVO50-48S1V2-4
	25 A	48 V (36 to 75 V)	2.3" x 0.9" x 0.38" (57.9 x 22.9 x 9.6)	86%	AVO75-48S1V2-4
	<b>Baseplate</b>				
	50 A	48 V (36 to 75 V)	2.3" x 0.9" x 0.5" (57.9 x 22.9 x 12.7)	85.5%	AVO100-48S1V2B-6L
3.3 V	<b>Open-frame</b>				
	15 A	48 V (36 to 75 V)	2.3" x 0.9" x 0.38" (57.9 x 22.9 x 9.6)	90%	AVO50C-48S3V3-6
	20 A	24 V/48 V (19 to 60 V)	2.3" x 0.9" x 0.32" (57.9 x 22.9 x 8.13)	91%	ALO20F36N-L
	20 A	48 V (36 to 75 V)	2.3" x 0.9" x 0.38" (57.9 x 22.9 x 9.6)	91%	AVO75-48S3V3-4
	30 A	48 V (36 to 75 V)	2.3" x 0.9" x 0.38" (57.9 x 22.9 x 9.6)	91%	AVO100B-48S3V3-6L
	60 A	48 V (36 to 75 V)	2.3" x 0.9" x 0.44" (58.4 x 22.9 x 11.2)	93.5%	ADO300-48S3V3-6L
	60 A	48 V (36 to 75 V)	2.3" x 0.9" x 0.44" (58.4 x 22.9 x 11.2)	93.5%	ADO300-48S3V3-6LI
	<b>Baseplate</b>				
	30 A	48 V (36 to 75 V)	2.3" x 0.9" x 0.4" (57.9 x 22.9 x 10.16)	91%	AVO100C-48S3V3B-4L
	60 A	48 V (36 to 75 V)	2.3" x 0.9" x 0.53" (58.4 x 22.9 x 13.5)	93.5%	ADO300-48S3V3B-6L
60 A	48 V (36 to 75 V)	2.3" x 0.9" x 0.53" (58.4 x 22.9 x 13.5)	93.5%	ADO300-48S3V3B-6LI	



Ordering Information						
Vout	Iout	Input Voltage	Package L x W x H (mm)	Efficiency	Model Number	
5 V	<b>Open-frame</b>					
	10 A	48 V (36 to 75 V)	2.3" x 0.9" x 0.38" (57.9 x 22.9 x 9.6)	91%	AVO50-48S05-4	
	15 A	48 V (36 to 75 V)	2.3" x 0.9" x 0.38" (57.9 x 22.9 x 9.6)	91%	AVO75-48S05-6	
	20 A	48 V (36 to 75 V)	2.3" x 0.9" x 0.38" (57.9 x 22.9 x 9.6)	92.8%	AVO100-48S05-6L	
	40 A	48 V (36 to 75 V)	2.3" x 0.9" x 0.38" (57.9 x 22.9 x 9.6)	94%	AVO200-48S05-6L	
	60 A	48 V (36 to 75 V)	2.3" x 0.9" x 0.44" (58.4 x 22.9 x 11.2)	95%	ADO300-48S05-6L	
	60 A	48 V (36 to 75 V)	2.3" x 0.9" x 0.44" (58.4 x 22.9 x 11.2)	95%	ADO300-48S05-6LI	
	<b>Baseplate</b>					
	20 A	48 V (36 to 75 V)	2.3" x 0.9" x 0.5" (57.9 x 22.9 x 12.7)	92.8%	AVO100-48S05B-6L	
	40 A	48 V (36 to 75 V)	2.3" x 0.9" x 0.5" (57.9 x 22.9 x 12.7)	94%	AVO200-48S05B-6L	
	60 A	48 V (36 to 75 V)	2.3" x 0.9" x 0.53" (58.4 x 22.9 x 13.5)	95%	ADO300-48S05B-6L	
	60 A	48 V (36 to 75 V)	2.3" x 0.9" x 0.53" (58.4 x 22.9 x 13.5)	95%	ADO300-48S05B-6LI	
	60 A	48 V (36 to 75 V)	2.3" x 0.9" x 0.53" (58.4 x 22.9 x 13.5)	95%	ADO300-48S05PB-6L	
	10.1 V	<b>Baseplate</b>				
		50 A	48 V (45 to 56 V)	2.3" x 0.91" x 0.48" (58.4 x 23.2 x 12.2)	96.5%	ADO500-48S10-4L
55 A		48 V (45 to 56 V)	2.3" x 0.91" x 0.57" (58.4 x 23.2 x 14.5)	96.5%	ADO550-48S10B-4L	
12 V	<b>Open-frame</b>					
	4.2 A	48 V (36 to 75 V)	2.3" x 0.9" x 0.38" (57.9 x 22.9 x 9.6)	91%	AVO50-48S12-6L	
	6.3 A	48 V (36 to 75 V)	2.3" x 0.9" x 0.38" (57.9 x 22.9 x 9.6)	91%	AVO75-48S12P-4	
	10 A	48 V (36 to 75 V)	2.3" x 0.9" x 0.38" (57.9 x 22.9 x 9.6)	93%	AVO120-48S12-6L	
	17 A	48 V (36 to 75 V)	2.3" x 0.9" x 0.38" (57.9 x 22.9 x 9.6)	94%	AVO200-48S12-6L	
	20 A	48 V (41 to 75 V)	2.3" x 0.9" x 0.38" (57.9 x 22.9 x 9.6)	94%	AVO240-48S12-6L	
	26 A	48 V (36 to 75 V)	2.3" x 0.9" x 0.44" (57.9 x 22.9 x 11.2)	95%	ADO300-48S12-6L	
	26 A	48 V (36 to 75 V)	2.3" x 0.9" x 0.44" (57.9 x 22.9 x 11.2)	95%	ADO300-48S12-6LI	
	<b>Baseplate</b>					
	4 A	48 V (36 to 75 V)	2.3" x 0.9" x 0.4" (57.9 x 22.9 x 10.16)	93%	AEO04B48N-L	
	10 A	48 V (36 to 75 V)	2.3" x 0.9" x 0.5" (57.9 x 22.9 x 12.7)	93%	AVO120-48S12B-6L	
	17 A	48 V (36 to 75 V)	2.3" x 0.9" x 0.5" (57.9 x 22.9 x 12.7)	94%	AVO200-48S12B-6L	
	20 A	48 V (41 to 75 V)	2.3" x 0.9" x 0.5" (57.9 x 22.9 x 12.7)	94%	AVO240-48S12B-6L	
	26 A	48 V (36 to 75 V)	2.3" x 0.9" x 0.53" (57.9 x 22.9 x 13.5)	95%	ADO300-48S12B-6L	
	26 A	48 V (36 to 75 V)	2.3" x 0.9" x 0.53" (57.9 x 22.9 x 13.5)	95%	ADO300-48S12B-6LI	

# Sixteenth-Brick

## SPECIAL FEATURES

- Industry leading sixteenth-brick standard package and feature sets
- Scalable offering: 35 W, 50 W, 75 W, 85 W and 120 W platforms
- Mechanical options for optimum mounting flexibility: Through-hole (default) or surface mount (suffix “-S”) termination; 5 mm (default) or 3.7 mm through-hole pin length option
- Meets basic insulation
- Power densities as high as 146.5 W per in<sup>3</sup>
- International safety standards approvals – UL, CSA, TÜV



Ordering Information					
Vout	Iout	Input Voltage	Package L x W x H (mm)	Efficiency	Model Number
1.2 V	<b>Open-frame</b>				
	15 A	48 V (36 to 75 V)	1.3" x 0.9" x 0.35" (33 x 22.9 x 8.89)	84%	ALD15K48N-L
	25 A	48 V (36 to 75 V)	1.3" x 0.9" x 0.34" (33 x 22.9 x 8.5)	84%	AVD75-48S1V2-6L
	<b>Baseplate</b>				
	25 A	48 V (36 to 75 V)	1.3" x 0.9" x 0.5" (33 x 22.9 x 12.7)	84%	AVD75-48S1V2B-6L
3.3 V	<b>Open-frame</b>				
	15 A	48 V (36 to 75 V)	1.3" x 0.9" x 0.37" (33 x 22.9 x 9.5)	91%	AVD50B-48S3V3-6L
	20 A	48 V (36 to 75 V)	1.3" x 0.9" x 0.39" (33 x 22.9 x 10)	92%	AVD75-48S3V3-6L
	23 A	48 V (36 to 75 V)	1.3" x 0.9" x 0.36" (33 x 22.9 x 9.2)	91.5%	AVD75B-48S3V3-6L
	25 A	48 V (36 to 75 V)	1.3" x 0.9" x 0.39" (33 x 22.9 x 10)	92%	AVD85-48S3V3-6L
	<b>Baseplate</b>				
	15 A	48 V (36 to 75 V)	1.3" x 0.9" x 0.47" (33 x 22.9 x 12)	92%	AVD50B-48S3V3B-6L
	20 A	48 V (36 to 75 V)	1.3" x 0.9" x 0.5" (33 x 22.9 x 12.7)	92%	AVD75-48S3V3B-6L
	23 A	48 V (36 to 75 V)	1.3" x 0.9" x 0.47" (33 x 22.9 x 12)	91.5%	AVD75B-48S3V3B-6L
	25 A	48 V (36 to 75 V)	1.3" x 0.9" x 0.5" (33 x 22.9 x 12.7)	92%	AVD85-48S3V3B-6L
	<b>SMT pin with reel tape package</b>				
	15 A	48 V (36 to 75 V)	1.3" x 0.9" x 0.37" (33 x 22.9 x 9.4)	92%	AVD50B-48S3V3TL
	23 A	48 V (36 to 75 V)	1.3" x 0.9" x 0.37" (33 x 22.9 x 9.4)	91.5%	AVD75B-48S3V3TL

Ordering Information					
Vout	Iout	Input Voltage	Package L x W x H (mm)	Efficiency	Model Number
5 V	<b>Open-frame</b>				
	7 A	48 V (36 to 75 V)	1.3" x 0.9" x 0.35" (33 x 22.9 x 8.89)	91%	ALD07A48N-L
	10 A	48 V (36 to 75 V)	1.3" x 0.9" x 0.36" (33 x 22.9 x 9.2)	91.5%	AVD50B-48S05-6L
	10 A	48 V (36 to 75 V)	1.3" x 0.9" x 0.37" (33 x 22.9 x 9.5)	92%	AVD50-48S05-6L
	15 A	48 V (36 to 75 V)	1.3" x 0.9" x 0.36" (33 x 22.9 x 9.2)	91.5%	AVD75B-48S05-6L
	17 A	48 V (36 to 75 V)	1.3" x 0.9" x 0.36" (33 x 22.9 x 9.2)	91.5%	AVD85B-48S05-6L
	17 A	48 V (36 to 75 V)	1.3" x 0.9" x 0.39" (33 x 22.9 x 10)	92%	AVD85-48S05-6L
	20 A	48 V (36 to 75 V)	1.3" x 0.9" x 0.39" (33 x 22.9 x 10)	92%	AVD100-48S05-6L
	<b>Baseplate</b>				
	10 A	48 V (36 to 75 V)	1.3" x 0.9" x 0.47" (33 x 22.9 x 12)	91.5%	AVD50B-48S05B-6L
	15 A	48 V (36 to 75 V)	1.3" x 0.9" x 0.47" (33 x 22.9 x 12)	91.5%	AVD75B-48S05B-6L
	17 A	48 V (36 to 75 V)	1.3" x 0.9" x 0.47" (33 x 22.9 x 12)	91.5%	AVD85B-48S05B-6L
	17 A	48 V (36 to 75 V)	1.3" x 0.9" x 0.5" (33 x 22.9 x 12.7)	92%	AVD85-48S05B-6L
	20 A	48 V (36 to 75 V)	1.3" x 0.9" x 0.5" (33 x 22.9 x 12.7)	92%	AVD100-48S05B-6L
	<b>SMT pin with reel tape package</b>				
	10 A	48 V (36 to 75 V)	1.3" x 0.9" x 0.37" (33 x 22.9 x 9.4)	91.5%	AVD50B-48S05TL
	15 A	48 V (36 to 75 V)	1.3" x 0.9" x 0.37" (33 x 22.9 x 9.4)	91.5%	AVD75B-48S05TL
	17 A	48 V (36 to 75 V)	1.3" x 0.9" x 0.37" (33 x 22.9 x 9.4)	91.5%	AVD85B-48S05TL
12 V	<b>Open-frame</b>				
	2.75 A	48 V (36 to 75 V)	1.3" x 0.9" x 0.35" (33 x 22.9 x 8.89)	92%	ALD03B48N-L
	4.17 A	48 V (36 to 75 V)	1.3" x 0.9" x 0.36" (33 x 22.9 x 9.2)	93%	AVD50B-48S12-6L
	6.25 A	48 V (36 to 75 V)	1.3" x 0.9" x 0.36" (33 x 22.9 x 9.2)	93.3%	AVD75B-48S12-6L
	7 A	48 V (36 to 75 V)	1.3" x 0.9" x 0.39" (33 x 22.9 x 10)	92%	AVD85-48S12-6L
	7.1 A	48 V (36 to 75 V)	1.3" x 0.9" x 0.36" (33 x 22.9 x 9.2)	93.3%	AVD85B-48S12-6L
	10 A	48 V (36 to 75 V)	1.3" x 0.9" x 0.39" (33 x 22.9 x 10)	92%	AVD120-48S12-6L
	17 A	48 V (36 to 75 V)	1.3" x 0.9" x 0.43" (33 x 22.9 x 10.9)	94.2%	AVD200-48S12-6L
	<b>Baseplate</b>				
	4.17 A	48 V (36 to 75 V)	1.3" x 0.9" x 0.47" (33 x 22.9 x 12)	93%	AVD50B-48S12B-6L
	6.25 A	48 V (36 to 75 V)	1.3" x 0.9" x 0.47" (33 x 22.9 x 12)	93.3%	AVD75B-48S12B-6L
	7 A	48 V (36 to 75 V)	1.3" x 0.9" x 0.5" (33 x 22.9 x 12.7)	92%	AVD85-48S12B-6L
	7.1 A	48 V (36 to 75 V)	1.3" x 0.9" x 0.47" (33 x 22.9 x 12)	93.3%	AVD85B-48S12B-6L
	10 A	48 V (36 to 75 V)	1.3" x 0.9" x 0.5" (33 x 22.9 x 12.7)	92%	AVD120-48S12B-6L
	17 A	48 V (36 to 75 V)	1.3" x 0.9" x 0.5" (33 x 22.9 x 12.7)	94.2%	AVD200-48S12B-6L
	<b>SMT pin with reel tape package</b>				
	4.17 A	48 V (36 to 75 V)	1.3" x 0.9" x 0.37" (33 x 22.9 x 9.4)	93%	AVD50B-48S12TL
	6.25 A	48 V (36 to 75 V)	1.3" x 0.9" x 0.37" (33 x 22.9 x 9.4)	93.3%	AVD75B-48S12TL
7.1 A	48 V (36 to 75 V)	1.3" x 0.9" x 0.37" (33 x 22.9 x 9.4)	93.3%	AVD85B-48S12TL	
17 A	48 V (36 to 75 V)	1.3" x 0.9" x 0.43" (33 x 22.9 x 10.9)	94.2%	AVD200-48S12TL	

# RF Power Bricks



## SPECIAL FEATURES

- Specialized high power bricks for RF applications such as base station power amplifiers
- Offered in 24 V and 48 V input voltages
- Wide output voltage adjustability
- 40 to 85°C for AVE, AGF baseplate temperature with No derating at rated power
- International safety standard approvals – UL, CSA, VDE, CB Report

Eight-Brick					
Vout	Iout	Input Voltage	Package L x W x H (mm)	Efficiency	Model Number
28 V	<b>Open-Frame</b>				
	3.57 A	48 V (36 to 75 V)	2.3" x 0.9" x 0.39" (57.9 x 22.9 x 9.6)	92%	AVO100-48S28-6L
	<b>Baseplate</b>				
	3.57 A	48 V (36 to 75 V)	2.3" x 0.9" x 0.5" (57.9 x 22.9 x 12.7)	92%	AVO100-48S28B-6L
	9 A	48 V (36 to 75 V)	2.3" x 0.9" x 0.5" (57.9 x 22.9 x 12.7)	93%	AVO250-48S28B-6L
Quarter-Brick					
Vout	Iout	Input Voltage	Package L x W x H (mm)	Efficiency	Model Number
50 V	<b>Baseplate</b>				
	10 A	48 V (36 to 75 V)	2.28" x 1.45" x 0.5" (57.9 x 36.8 x 12.7)	94%	AGQ500-48S50-6L
	10 A	48 V (36 to 75 V)	2.28" x 1.45" x 0.5" (57.9 x 36.8 x 12.7)	94%	AGQ500-48S50P-6L
Half-Brick					
Vout	Iout	Input Voltage	Package L x W x H (mm)	Efficiency	Model Number
28 V	<b>Aluminum Substrate</b>				
	12.5 A	24 V (18 to 36 V)	2.4" x 2.3" x 0.5" (61 x 57.9 x 12.7)	93%	AVE350-24S28-6L
	12.5 A	48 V (36 to 75 V)	2.4" x 2.3" x 0.5" (61 x 57.9 x 12.7)	93%	AVE350B-48S28-6
	16 A	48 V (36 to 75 V)	2.4" x 2.3" x 0.5" (61 x 57.9 x 12.7)	94%	AVE450B-48S28-6L/M
	25 A	48 V (36 to 65 V)	2.3" x 2.4" x 0.5" (57.9 x 61 x 12.7)	95%	ADH700-48S28-6L
	25 A	48 V (36 to 75 V)	2.3" x 2.4" x 0.5" (57.9 x 61 x 12.7)	95%	ADH700-48S28-6LS
	25 A	48 V (36 to 65 V)	2.3" x 2.4" x 0.5" (57.9 x 61 x 12.7)	95%	ADH700-48S28P-6L
	25 A	48 V (36 to 75 V)	2.3" x 2.4" x 0.5" (57.9 x 61 x 12.7)	95%	ADH700-48S28P-6LS
	<b>Baseplate</b>				
	25 A	48 V (36 to 75 V)	2.3" x 2.4" x 0.5" (57.9 x 61 x 12.7)	95.5%	AVE700-48S28B-6L
	25 A	48 V (36 to 75 V)	2.3" x 2.4" x 0.5" (57.9 x 61 x 12.7)	95.5%	AVE700-48S28PB-6L
	50 V	9 A	48 V (36 to 75 V)	2.3" x 2.4" x 0.5" (57.9 x 61 x 12.7)	95%
9 A		48 V (36 to 75 V)	2.3" x 2.4" x 0.5" (57.9 x 61 x 12.7)	95%	AVE450-48S50P-6L
10 A		48 V (36 to 75 V)	2.3" x 2.4" x 0.5" (57.9 x 61 x 12.7)	95%	AVE500-48S50-6L
10 A		48 V (36 to 75 V)	2.3" x 2.4" x 0.5" (57.9 x 61 x 12.7)	95%	AVE500-48S50P-6L
14 A		48 V (36 to 65 V)	2.3" x 2.4" x 0.5" (57.9 x 61 x 12.7)	95%	ADH700-48S50-6L
14 A		48 V (36 to 75 V)	2.3" x 2.4" x 0.5" (57.9 x 61 x 12.7)	95%	ADH700-48S50-6LS
14 A		48 V (36 to 65 V)	2.3" x 2.4" x 0.5" (57.9 x 61 x 12.7)	95%	ADH700-48S50P-6L
14 A		48 V (36 to 75 V)	2.3" x 2.4" x 0.5" (57.9 x 61 x 12.7)	95%	ADH700-48S50P-6LS
Full-Brick					
Vout	Iout	Input Voltage	Package L x W x H (mm)	Efficiency	Model Number
28 V	<b>Aluminum Substrate</b>				
	21.5 A	24 V (18 to 36 V)	4.6" x 2.4" x 0.5" (116.8 x 61 x 12.7)	93%	AGF600-24S28-6L
	21.5 A	48 V (36 to 75 V)	4.6" x 2.4" x 0.5" (116.8 x 61 x 12.7)	93.5%	AGF600-48S28-6L
	25 A	48 V (36 to 75 V)	4.6" x 2.4" x 0.5" (116.8 x 61 x 12.7)	93%	AGF700-48S30LT
	28.5 A	48 V (36 to 75 V)	4.6" x 2.4" x 0.5" (116.8 x 61 x 12.7)	94%	AGF800-48S28-6L
48 V	16 A	50 V (36 to 75 V)	4.6" x 2.4" x 0.5" (116.8 x 61 x 12.7)	94.5%	AGF800-48S48P-6L
30 V/5 V	23.3 A / 20 A	48 V (36 to 75 V)	4.6" x 2.4" x 0.5" (116.8 x 61 x 12.7)	93.5%	AGF800-48D3005-6L

# Wide Input Voltage Series

## SPECIAL FEATURES

- Wide input voltage range to cover 24 V and 48 V input
- Industry standard brick package
- Open-frame and baseplate construction
- Wide operating temperature



Ordering Information							
		Vout	Iout	Input Voltage	Package L x W x H (mm)	Efficiency	Model Number
Quarter Brick	Baseplate	3.3 V	25 A	24 V, 48 V (18 to 60 V)	90% @ 48 vin, 92% @ 24 vin	2.28" x 1.45" x 0.40" (57.9 x 36.8 x 10.2)	AVQ100-36S3V3B-6L
Quarter Brick	Baseplate	12 V	19 A	24 V, 48 V (18 to 75 V)	94%	2.28" x 1.45" x 0.50" (57.9 x 36.8 x 12.7)	AVQ200-36S12B-6L
Quarter Brick	Open-frame	3.3 V	25 A	24 V, 48 V (18 to 60 V)	90% @ 48 vin, 92% @ 24 vin	2.28" x 1.45" x 0.40" (57.9 x 36.8 x 10.2)	AVQ100-36S3V3-6L
Quarter Brick	Open-frame	12 V	19 A	24 V, 48 V (18 to 75 V)	94%	2.28" x 1.45" x 0.38" (57.9 x 36.8 x 9.6)	AVQ200-36S12-6L

# Direct Conversion - Power Stamp Alliance Series



ADC100M

ADC100S

## SPECIAL FEATURES

- 100 A peak current
- PSA compliant
- Up to 93% efficient
- Low ripple and Noise
- Data center 48 VDC input range
- Open frame optimized for air cooling
- Surface mount termination
- Fixed switching frequency
- High capacitive load capability
- Pre-bias start-up capability
- High reliability
- RoHS 3.0 compliant
- UL94 V-0 materials

Ordering Information						
Iout	Input Voltage	Vout	Efficiency	Package L x W x H (mm)	Model Number	
40 to 60 VDC	5 V / V <sub>dd</sub> & 5 V / V <sub>cc</sub>	0.5 A / 2 A		1.18" x 0.5" x 0.415" (20.8 x 12.7 x 10.55)	ADC100C	
40 to 60 VDC	1.6 to 2.0 V	100 A	92%	1.18" x 0.5" x 0.67" (30 x 12.7 x 17)	ADC100M-04Y	
40 to 60 VDC	1.6 to 2.0 V	100 A	92%	1.18" x 0.5" x 0.59" (30 x 12.7 x 15)	ADC100S-04Y	

## INDUSTRY STANDARD NON-ISOLATED

# C-Class – High Density

## Non-Isolated DC–DC Converters

The second generation C-class non-isolated DC–DC converters are designed to provide good efficiency and performance, a smaller footprint, and integrated input and output capacitors.



## SPECIAL FEATURES

- Wide input voltage ranges: 3 to 13.8 V or 4.5 to 13.8 V
- Wide output voltage trim/adjustability: 0.59 to 5.1 V
- Output current: 3 to 40 A
- High efficiency up to 94%
- Remote sense (Sxx20C2, Sxx40C2 and Sxx60C2)
- Operating temperature range for LDO03, LDO06, LDO10: -40 to 85°C.
- Operating temperature range for SIL/SMT20C2, SIL/SMT40C2 and SIL60C2: 0 to 70°C
- Cost-optimized design – industry leading value
- Compact footprint, vertical, horizontal and horizontal SMT options
- International safety standard approvals – UL, CSA, TÜV & CB Report

Ordering Information					
Output Current	Input Voltage	Output Voltage	Efficiency	Package L x W x H (mm)	Model Number
<b>Single-In-Line, Through-Hole Mounting</b>					
3 A	3.0 to 13.8 VDC	0.59 to 5.1 V	90%	0.37" x 0.21" x 0.61" (9.4 x 5.33 x 15.49)	LDO03C-005W05-VJ
6 A	3.0 to 13.8 VDC	0.59 to 5.1 V	92%	0.41" x 0.37" x 0.65" (10.41 x 9.4 x 16.51)	LDO06C-005W05-VJ
10 A	3.0 to 13.8 VDC	0.59 to 5.1 V	94%	0.41" x 0.45" x 0.65" (10.41 x 11.43 x 16.51)	LDO10C-005W05-VJ
20 A	4.5 to 13.8 VDC	0.59 to 5.1 V	93%	1.2" x 0.46" x 0.61" (30.48 x 11.68 x 15.49)	SIL20C2-00SADJ-VJ
40 A	4.5 to 13.8 VDC	0.6 to 5.0 V	94%	1.2" x 0.43" x 1.1" (30.48 x 10.92 x 27.94)	SIL40C2-00SADJ-VJ
60 A	10.8 to 13.2 VDC	1.2 to 4.0 V	89%	1.98" x 0.54" x 0.78" (50.29 x 13.72 x 19.81)	SIL60C2-00SADJ-VDJ
<b>Surface-Mounting</b>					
3 A	3.0 to 13.8 VDC	0.59 to 5.1 V	90%	0.61" x 0.37" x 0.29" (15.49 x 9.4 x 7.37)	LDO03C-005W05-SJ
6 A	3.0 to 13.8 VDC	0.59 to 5.1 V	92%	0.65" x 0.41" x 0.44" (16.51 x 10.41 x 11.18)	LDO06C-005W05-SJ
10 A	3.0 to 13.8 VDC	0.59 to 5.1 V	94%	0.65" x 0.41" x 0.52" (16.51 x 10.41 x 13.21)	LDO10C-005W05-SJ
20 A	4.5 to 13.8 VDC	0.59 to 5.1 V	93%	1.2" x 0.61" x 0.48" (30.48 x 15.49 x 12.19)	SMT20C2-00SADJJ
40 A	4.5 to 13.8 VDC	0.6 to 5.0 V	94%	1.2" x 1.1" x 0.44" (30.48 x 27.94 x 11.18)	SMT40C2-00SADJJ

# LGA Series

## Dual Output Non-Isolated Digital DC-DC Converter



### SPECIAL FEATURES

- Two-phase design
- Dual or single output configuration possible
- High efficiency up to 95.5%
- Small size 1" x 0.5" x 0.48" (L x W x H)
- Support PMBus
- No minimum load requirement
- Wide operating temperature range
- Exceptional power density
- Automatic loop compensation
- Excellent transient response
- Analog or digital control
- IPC9592B compliant
- Tape and reel packaging
- Reflow compatible
- Can stack up to 8 phases, with an output of 320 A
- Two-year warranty
- Evaluation kit is available

Ordering Information					
Output Current	Input Voltage	Output Voltage	Efficiency	Package L x W x H (mm)	Model Number
Total Output: 50 A	7.5 to 14 VDC	0.6 to 3.3 VDC	95.5%	1" x 0.5" x 0.48" (25.4 x 12.7 x 5.85)	LGA50D-01DADJ
Channel 1: 25 A	7.5 to 14 VDC	0.6 to 5 VDC	95.5%	1" x 0.5" x 0.48" (25.4 x 12.7 x 12.2)	LGA50D-01DADJ
Channel 2: 25 A	7.5 to 14 VDC	0.6 to 5 VDC	95.5%	1" x 0.5" x 0.48" (25.4 x 12.7 x 10.6)	LGA50D-01DADJ
Total Output: 80 A	7.5 to 14 VDC	0.6 to 5 VDC	95.5%	1" x 0.5" x 0.48" (25.4 x 12.7 x 12.2)	LGA80D-00DADJJ
Channel 1: 40 A	7.5 to 14 VDC	0.6 to 5 VDC	95.5%	1" x 0.5" x 0.48" (25.4 x 12.7 x 12.2)	LGA80D-00DADJJ
Channel 2: 40 A	7.5 to 14 VDC	0.6 to 5 VDC	95.5%	1" x 0.5" x 0.48" (25.4 x 12.7 x 12.2)	LGA80D-00DADJJ

# C-Class – High Density LGA C Series

The latest addition to the c-class non-isolated DC-DC converter offering packaged in an ultra-compact, low-profile land grid array with current densities up to 225 A/in<sup>3</sup>.



### SPECIAL FEATURES

- High density, ultra low profile surface mount module in Land Grid Array (LGA) package
- Available in 4 different output current levels: 3, 6, 10 and 20 Amps
- Wide input voltage range: 3.0 to 14.0 V
- Adjustable output voltage: 0.59 to 5.1 V via external resistor
- High efficiency ~92% typical
- Wide ambient operating temperature range: -40 to 85°C
- Input UVLO; remote On/Off; output adjust; margin; PGood signal, differential sense
- Current sink capability for voltage termination applications
- Integrated input and output capacitors resulting in minimal external capacitance required for stable operation

Ordering Information					
Output Current	Input Voltage	Output Voltage	Efficiency	Package L x W x H (mm)	Model Number
<b>Surface-Mounting</b>					
3 A	3.0 to 14 VDC	0.59 to 5.1 V	92%	0.65" x 0.65" x 0.129" (16.51 x 16.51 x 3.27)	LGA03C-00SADJJ
6 A	3.0 to 14 VDC	0.59 to 5.1 V	92%	0.65" x 0.65" x 0.129" (16.51 x 16.51 x 3.27)	LGA06C-00SADJJ
10 A	3.0 to 14 VDC	0.59 to 5.1 V	92%	0.65" x 0.65" x 0.129" (16.51 x 16.51 x 3.27)	LGA10C-00SADJJ
20 A	4.5 to 14 VDC	0.59 to 5.1 V	91%	0.65" x 0.65" x 0.210" (16.51 x 16.51 x 5.33)	LGA20C-01SADJJ

<sup>1</sup> Optional heatsink kits are available. Ordering part number is LGA-HTSK-KIT-XXX  
 XXX = Total height of the LGA20C-01SADJJ with heatsink attached: 045 = 0.45"; 048 = 0.48"; 050 = 0.50"

# POLA – General Purpose

Choose POLA Modules for Multi-sourced and Interoperable Parts



## SPECIAL FEATURES

- Input voltage ranges: 2.95 to 3.65 V, 4.5 to 5.5 V, 10.8 to 13.2 V
- Wide output voltage trim and adjustability: 0.8 to 5.5 V
- Output current: 6 to 60 A
- High efficiency up to 96%
- Auto-Track™ Sequencing
- Margin up/down controls
- Pre-bias start-up capability
- Remote on/off
- Remote sense
- POLA compatible
- True multi-sourcing flexibility (form, fit and function)
- Operating temperature range: -40 to 85°C
- Protection: overcurrent/short-circuit
- Through-hole or surface-mount
- International safety standard approvals – UL, CSA, TÜV & CB Report

Ordering Information					
Output Current	Input Voltage	Output Voltage	Efficiency	Package L x W x H (mm)	Model Number <sup>1</sup>
6 A	2.95 to 3.65 VDC	0.8 to 2.5 V	94%	0.87" x 0.495" x 0.335" (22.01 x 12.57 x 8.51)	PTH03050WAD
6 A	4.5 to 5.5 VDC	0.8 to 3.6 V	95%	0.87" x 0.495" x 0.335" (22.01 x 12.57 x 8.51)	PTH05050WAD
6 A	10.8 to 13.2 VDC	1.2 to 5.5 V	93%	0.87" x 0.495" x 0.335" (22.01 x 12.57 x 8.51)	PTH12050WAD
8 A	2.95 to 3.65 VDC	0.8 to 2.5 V	93%	0.9" x 0.33" x 0.4" (22.86 x 8.38 x 10.16)	PTV03010WAD
8 A	4.5 to 5.5 VDC	0.8 to 3.6 V	95%	0.9" x 0.33" x 0.4" (22.86 x 8.38 x 10.16)	PTV05010WAD
8 A	10.8 to 13.2 VDC	1.2 to 5.5 V	92%	0.9" x 0.33" x 0.4" (22.86 x 8.38 x 10.16)	PTV12010WAD
10 A	2.95 to 3.65 VDC	0.8 to 2.5 V	93%	0.995" x 0.62" x 0.354" (25.27 x 15.75 x 8.99)	PTH03060WAD
10 A	4.5 to 5.5 VDC	0.8 to 3.6 V	94%	0.995" x 0.62" x 0.354" (25.27 x 15.75 x 8.99)	PTH05060WAD
10 A	10.8 to 13.2 VDC	1.2 to 5.5 V	94%	0.995" x 0.62" x 0.354" (25.27 x 15.75 x 8.99)	PTH12060WAD
12 A	10.8 to 13.2 VDC	1.2 to 5.5 V	94%	1.370" x 0.62" x 0.354" (34.80 x 15.75 x 8.99)	PTH12010WAD
15 A	2.95 to 3.65 VDC	0.8 to 2.5 V	93%	1.370" x 0.62" x 0.354" (34.80 x 15.75 x 8.99)	PTH03010WAD
15 A	4.5 to 5.5 VDC	0.8 to 3.6 V	95%	1.370" x 0.62" x 0.354" (34.80 x 15.75 x 8.99)	PTH05010WAD
16 A	10.8 to 13.2 VDC	1.2 to 5.5 V	93%	1.750" x 0.37" x 0.500" (44.45 x 9.4 x 12.7)	PTV12020WAD
18 A	2.95 to 3.6 VDC	0.8 to 2.5 V	95%	1.750" x 0.37" x 0.500" (44.45 x 9.4 x 12.7)	PTV03020WAD
18 A	4.5 to 5.5 VDC	0.8 to 3.6 V	94%	1.750" x 0.37" x 0.500" (44.45 x 9.4 x 12.7)	PTV05020WAD
18 A	10.8 to 13.2 VDC	1.2 to 5.5 V	95%	1.495" x 0.87" x 0.354" (37.97 x 22.01 x 8.99)	PTH12020WAD
22 A	2.95 to 3.65 VDC	0.8 to 2.5 V	95%	1.495" x 0.87" x 0.354" (37.97 x 22.01 x 8.99)	PTH03020WAD
22 A	4.5 to 5.5 VDC	0.8 to 3.6 V	96%	1.495" x 0.87" x 0.354" (37.97 x 22.01 x 8.99)	PTH05020WAD
26 A	10.2 to 13.8 VDC	1.2 to 5.5 V	95%	1.37" x 1.12" x 0.354" (34.80 x 28.45 x 8.99)	PTH12030WAD
30 A	2.95 to 3.65 VDC	0.8 to 2.5 V	93%	1.37" x 1.12" x 0.354" (34.80 x 28.45 x 8.99)	PTH03030WAD
30 A	4.5 to 5.5 VDC	0.8 to 3.6 V	94%	1.37" x 1.12" x 0.354" (34.80 x 28.45 x 8.99)	PTH05030WAD
50 A	8.0 to 14 VDC	0.8 to 5.5 V	96%	2.045" x 1.045" x 0.357" (51.94 x 26.54 x 9.07)	PTH12040WAD
60 A	2.95 to 2.5 VDC	0.8 to 2.5 V	96%	2.045" x 1.045" x 0.357" (51.94 x 26.54 x 9.07)	PTH04040WAD

<sup>1</sup> Mounting Option Suffix:  
D Horizontal through-hole (RoHS 6/6)  
Z Surface-mount solder ball (RoHS 6/6)



# Digital DC-DC Converters

## SPECIAL FEATURES

- PMBus™ compliant control and monitoring functions available on all digital DC-DC products
- Popular monitoring functions such as temperature, voltage, and current are all available
- Control functions for enabling and sequencing are all available.

## ISOLATED DC-DC SPECIAL FEATURES

- Isolated DC-DC converters follow the DOSA standard footprints for digital interface bricks

Ordering Information					
Vout	Iout	Input Voltage	Package size	Efficiency	Model Number
12 VDC	26 A	48 V (36 to 75 V)	Eighth brick	95%	ADO300-48S12-6LI
	26 A	48 V (36 to 75 V)	Eighth brick	95%	ADO300-48S12B-6LI
	42 A	48 V (36 to 75 V)	Quarter brick	95%	ADQ500-48S12-6LI
	42 A	48 V (36 to 75 V)	Quarter brick	95%	ADQ500-48S12B-6LI
	58 A	48 V (40 to 60 V)	Quarter brick	96%	ADQ700-48S12-LI
	58 A	48 V (40 to 60 V)	Quarter brick	96%	ADQ700-48S12B-6LI
	90 A	48 V (40 to 60 V)	Quarter brick	97.5%	BDQ1300-48S12B-4LI

## NON-ISOLATED DC-DC SPECIAL FEATURES

- Non-isolated LGA50D has dual independently controlled channels of up to 25 A per channel
- Non-isolated LGA80D has dual independently controlled channels of up to 40 A per channel
- Provides current density of 160 A per in<sup>2</sup>
- Evaluation kit available

Ordering Information					
Output Current	Input Voltage	Output Voltage	Efficiency	Package L x W x H (mm)	Model Number
<b>Total Output: 50 A</b>	7.5 to 14 VDC	0.6 to 3.3 VDC	95.5%	1" x 0.5" x 0.48" (25.4 x 12.7 x 5.85)	LGA50D-01DADJ
<b>Channel 1: 25 A</b>	7.5 to 14 VDC	0.6 to 5 VDC	95.5%	1" x 0.5" x 0.48" (25.4 x 12.7 x 12.2)	LGA50D-01DADJ
<b>Channel 2: 25 A</b>	7.5 to 14 VDC	0.6 to 5 VDC	95.5%	1" x 0.5" x 0.48" (25.4 x 12.7 x 10.6)	LGA50D-01DADJ
<b>Total Output: 80 A</b>	7.5 to 14 VDC	0.6 to 5 VDC	95.5%	1" x 0.5" x 0.48" (25.4 x 12.7 x 12.2)	LGA80D-00DADJJ
<b>Channel 1: 40 A</b>	7.5 to 14 VDC	0.6 to 5 VDC	95.5%	1" x 0.5" x 0.48" (25.4 x 12.7 x 12.2)	LGA80D-00DADJJ
<b>Channel 2: 40 A</b>	7.5 to 14 VDC	0.6 to 5 VDC	95.5%	1" x 0.5" x 0.48" (25.4 x 12.7 x 12.2)	LGA80D-00DADJJ



LGA80D-00SADJJ



LGA50D-EVAL-KIT

# On-Board AC-DC Distributed Architecture

- High power and high density AC-DC building blocks for quick-turn and modular power solutions
- Alternative power solutions vs. custom development approach
- No fans and high reliability (1M hours MTBF)
- Suitable for harsh temperature conditions (-40°C start-up/-20 to 100°C operating temperature)
- RTCA-DO Compliant for some AIQ/AIT models

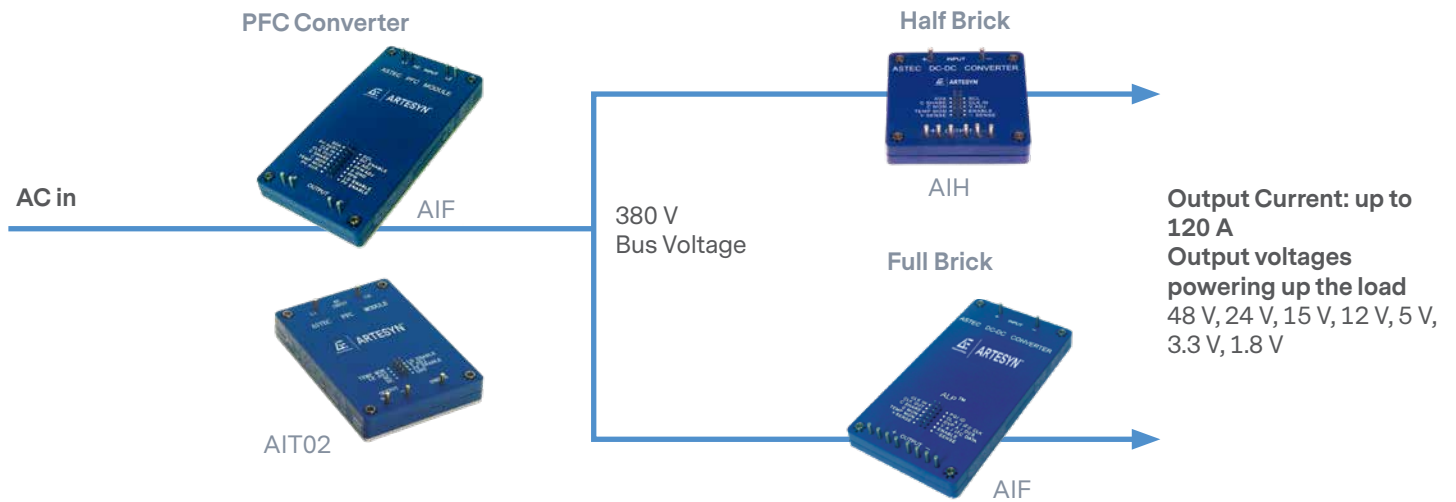

# Power Factor Correction (PFC)



## SPECIAL FEATURES

- 1600 W/720 W/75 W
- Unity power factor
- Universal input and frequency range
- Positive and negative enable
- Paralleling with current share
- IEC 1000-3.2 compliance
- 100°C baseplate
- Clock synch (in/out)
- Current monitoring
- Vout adjust
- On/off enable
- Remote sense
- 95% efficiency
- Fast transient response

Ordering Information						
	Vout	Iout	Input Voltage	Package L x W x H (mm)	Efficiency	Model Number
<b>PFC Module - Baseplate</b>						
	380 V	4.2 A	85 to 264 VAC	4.6" x 2.4" x 0.5" (116.84 x 60.96 x 12.7)	95%	AIF04ZPFC-01L
	380 V	4.2 A	85 to 264 VAC	4.6" x 2.4" x 0.5" (116.84 x 60.96 x 12.7)	95%	AIF04ZPFC-02L
	393 V	0.25 A	100 to 122 VAC	2.3" x 1.45" x 0.5" (58.42 x 36.83 x 12.7)	90%	AIQ00ZPFC-01NL
	393 V	2.08 A	85 to 264 VAC	3.5" x 2.4" x 0.5" (88.9 x 60.96 x 12.7)	93%	AIT02ZPFC-01NL
	400 V	6 A	85 to 264 VAC	4.6" x 2.4" x 0.55" (116.8 x 60.96 x 13.95)	97%	AIF06ZPFC-01L
	400 V	6 A	85 to 264 VAC	4.6" x 2.4" x 0.55" (116.8 x 60.96 x 13.95)	97%	AIF06ZPFC-02L

1 85°C temperature

# High Power 300 Vin

## SPECIAL FEATURES

- 300 V input (250 to 420 V PFC-ready)
- 2nd generation product
- Standard through-hole termination
- Power density > 100 W/in<sup>3</sup>
- 100°C max baseplate operating temperature
- Embedded controls on secondary side (Full- and Half-brick):
  - Temp monitor
  - Current sharing
  - Power good signal
  - Current limit & OVP adjust



300 V input 65 to 600 W output

Ordering Information						
	Vout	Iout	Input Voltage	Package L x W x H (mm)	Efficiency	Model Number
<b>AIF 300 Vin - Full-Brick - Baseplate</b>						
	1.8 V	120 A	300 V (250 to 420 V)	4.6" x 2.4" x 0.5" (116.84 x 60.96 x 12.7)	80%	AIF120Y300-L
	3.3 V	120 A	300 V (250 to 420 V)	4.6" x 2.4" x 0.5" (116.84 x 60.96 x 12.7)	87%	AIF120F300-L
	5 V	80 A	300 V (250 to 420 V)	4.6" x 2.4" x 0.5" (116.84 x 60.96 x 12.7)	90%	AIF80A300-L
	12 V	50 A	300 V (250 to 420 V)	4.6" x 2.4" x 0.5" (116.84 x 60.96 x 12.7)	90%	AIF50B300-L
	15 V	40 A	300 V (250 to 420 V)	4.6" x 2.4" x 0.5" (116.84 x 60.96 x 12.7)	90%	AIF40C300-L
	24 V	25 A	300 V (250 to 420 V)	4.6" x 2.4" x 0.5" (116.84 x 60.96 x 12.7)	90%	AIF25H300-L
	48 V	12 A	300 V (250 to 420 V)	4.6" x 2.4" x 0.5" (116.84 x 60.96 x 12.7)	91%	AIF12W300-L
<b>AIH 300 Vin - Half-Brick - Baseplate</b>						
	1.8 V	50 A	300 V (250 to 420 V)	2.3" x 2.4" x 0.5" (58.42 x 60.96 x 12.7)	80%	AIH50Y300-L
	3.3 V	50 A	300 V (250 to 420 V)	2.3" x 2.4" x 0.5" (58.42 x 60.96 x 12.7)	85%	AIH50F300-L
	5 V	40 A	300 V (250 to 420 V)	2.3" x 2.4" x 0.5" (58.42 x 60.96 x 12.7)	88%	AIH40A300-L
	12 V	20 A	300 V (250 to 420 V)	2.3" x 2.4" x 0.5" (58.42 x 60.96 x 12.7)	90%	AIH20B300-L
	15 V	16 A	300 V (250 to 420 V)	2.3" x 2.4" x 0.5" (58.42 x 60.96 x 12.7)	90%	AIH16C300-L
	24 V	10 A	300 V (250 to 420 V)	2.3" x 2.4" x 0.5" (58.42 x 60.96 x 12.7)	90%	AIH10H300-L
<b>AIQ 300 Vin - Quarter-Brick - Baseplate</b>						
	28 V	2.32 A	300 V (250 to 420 V)	2.3" x 1.45" x 0.5" (58.42 x 36.83 x 12.7)	89%	AIQ02R300L

1 85°C temperature

# Low Power Isolated DC-DC Product



## SPECIAL FEATURES

- Input voltages 9 to 36 V, 18 to 36 V, 18 to 75 V and 36 to 75 V
- Single and dual outputs
- Power 2 to 50 W
- Regulated outputs
- Over-current protection
- Operating temperature -40 to 71°C (ambient)
- 1500 VDC isolation
- CE Mark Safety
- UL Approval (Except AET Series)

Low Power Isolated DC-DC						
	Input Voltage	Output Voltage	Package L x W x H (mm)	I/O Isolation	Efficiency	Model Number
3 W	<b>Enclosed</b>					
	4.5 to 10 VDC	3.3 V @ 0.6 A	0.55" x 0.55" x 0.31" (14 x 14 x 8)	1500 VDC	79%	AYA01F05-L
	4.5 to 10 VDC	5 V @ 0.6 A	0.55" x 0.55" x 0.31" (14 x 14 x 8)	1500 VDC	81%	AYA01A05-L
	4.5 to 10 VDC	12 V @ 0.25 A	0.55" x 0.55" x 0.31" (14 x 14 x 8)	1500 VDC	85%	AYA01B05-L
	4.5 to 10 VDC	15 V @ 0.2 A	0.55" x 0.55" x 0.31" (14 x 14 x 8)	1500 VDC	85%	AYA01C05-L
	4.5 to 10 VDC	±5 V @ 0.3 A	0.55" x 0.55" x 0.31" (14 x 14 x 8)	1500 VDC	82%	AYA01AA05-L
	4.5 to 10 VDC	±12 V @ 0.125 A	0.55" x 0.55" x 0.31" (14 x 14 x 8)	1500 VDC	84%	AYA01BB05-L
	4.5 to 10 VDC	±15 V @ 0.1 A	0.55" x 0.55" x 0.31" (14 x 14 x 8)	1500 VDC	85%	AYA01CC05-L
	9 to 18 VDC	3.3 V @ 0.6 A	0.55" x 0.55" x 0.31" (14 x 14 x 8)	1500 VDC	80%	AYA01F12-L
	9 to 18 VDC	5 V @ 0.6 A	0.55" x 0.55" x 0.31" (14 x 14 x 8)	1500 VDC	83%	AYA01A12-L
	9 to 18 VDC	12 V @ 0.25 A	0.55" x 0.55" x 0.31" (14 x 14 x 8)	1500 VDC	87%	AYA01B12-L
	9 to 18 VDC	15 V @ 0.2 A	0.55" x 0.55" x 0.31" (14 x 14 x 8)	1500 VDC	87%	AYA01C12-L
	9 to 18 VDC	±5 V @ 0.3 A	0.55" x 0.55" x 0.31" (14 x 14 x 8)	1500 VDC	84%	AYA01AA12-L
	9 to 18 VDC	±12 V @ 0.125 A	0.55" x 0.55" x 0.31" (14 x 14 x 8)	1500 VDC	86%	AYA01BB12-L
	9 to 18 VDC	±15 V @ 0.1 A	0.55" x 0.55" x 0.31" (14 x 14 x 8)	1500 VDC	87%	AYA01CC12-L
	9 to 36 VDC	3.3 V @ 0.6 A	0.94" x 0.54" x 0.31" (23.8 x 13.7 x 8)	1500 VDC	75%	ATA00F18-L
	9 to 36 VDC	3.3 V @ 0.6 A	0.94" x 0.54" x 0.31" (23.8 x 13.7 x 8) SMT	1500 VDC	75%	ATA00F18S-L
	9 to 36 VDC	5 V @ 0.6 A	0.94" x 0.54" x 0.31" (23.8 x 13.7 x 8)	1500 VDC	78%	ATA00A18-L
	9 to 36 VDC	5 V @ 0.6 A	0.94" x 0.54" x 0.31" (23.8 x 13.7 x 8) SMT	1500 VDC	78%	ATA00A18S-L
	9 to 36 VDC	12 V @ 0.25 A	0.94" x 0.54" x 0.31" (23.8 x 13.7 x 8)	1500 VDC	80%	ATA00B18-L
	9 to 36 VDC	12 V @ 0.25 A	0.94" x 0.54" x 0.31" (23.8 x 13.7 x 8) SMT	1500 VDC	80%	ATA00B18S-L
	9 to 36 VDC	15 V @ 0.2 A	0.94" x 0.54" x 0.31" (23.8 x 13.7 x 8)	1500 VDC	80%	ATA00C18-L
	9 to 36 VDC	15 V @ 0.2 A	0.94" x 0.54" x 0.31" (23.8 x 13.7 x 8) SMT	1500 VDC	80%	ATA00C18S-L
	9 to 36 VDC	24 V @ 0.125 A	0.94" x 0.54" x 0.31" (23.8 x 13.7 x 8)	1500 VDC	80%	ATA00H18-L
	9 to 36 VDC	24 V @ 0.125 A	0.94" x 0.54" x 0.31" (23.8 x 13.7 x 8) SMT	1500 VDC	80%	ATA00H18S-L
	9 to 36 VDC	±5 V @ 0.3 A	0.94" x 0.54" x 0.31" (23.8 x 13.7 x 8)	1500 VDC	77%	ATA00AA18-L
	9 to 36 VDC	±5 V @ 0.3 A	0.94" x 0.54" x 0.31" (23.8 x 13.7 x 8) SMT	1500 VDC	77%	ATA00AA18S-L
	9 to 36 VDC	±12 V @ 0.125 A	0.94" x 0.54" x 0.31" (23.8 x 13.7 x 8)	1500 VDC	80%	ATA00BB18-L
	9 to 36 VDC	±12 V @ 0.125 A	0.94" x 0.54" x 0.31" (23.8 x 13.7 x 8) SMT	1500 VDC	80%	ATA00BB18S-L

Low Power Isolated DC-DC						
	Input Voltage	Output Voltage	Package L x W x H (mm)	I/O Isolation	Efficiency	Model Number
3 W	9 to 36 VDC	±15 V @ 0.1 A	0.94" x 0.54" x 0.31" (23.8 x 13.7 x 8)	1500 VDC	80%	ATA00CC18-L
	9 to 36 VDC	±15 V @ 0.1 A	0.94" x 0.54" x 0.31" (23.8 x 13.7 x 8) SMT	1500 VDC	80%	ATA00CC18S-L
	18 to 36 VDC	3.3 V @ 0.6 A	0.55" x 0.55" x 0.31" (14 x 14 x 8)	1500 VDC	80%	AYA01F24-L
	18 to 36 VDC	5 V @ 0.6 A	0.55" x 0.55" x 0.31" (14 x 14 x 8)	1500 VDC	83%	AYA01A24-L
	18 to 36 VDC	12 V @ 0.25 A	0.55" x 0.55" x 0.31" (14 x 14 x 8)	1500 VDC	87%	AYA01B24-L
	18 to 36 VDC	15 V @ 0.2 A	0.55" x 0.55" x 0.31" (14 x 14 x 8)	1500 VDC	87%	AYA01C24-L
	18 to 36 VDC	±5 V @ 0.3 A	0.55" x 0.55" x 0.31" (14 x 14 x 8)	1500 VDC	84%	AYA01AA24-L
	18 to 36 VDC	±12 V @ 0.125 A	0.55" x 0.55" x 0.31" (14 x 14 x 8)	1500 VDC	86%	AYA01BB24-L
	18 to 36 VDC	±15 V @ 0.1 A	0.55" x 0.55" x 0.31" (14 x 14 x 8)	1500 VDC	87%	AYA01CC24-L
	18 to 75 VDC	3.3 V @ 0.6 A	0.94" x 0.54" x 0.31" (23.8 x 13.7 x 8)	1500 VDC	75%	ATA00F36-L
	18 to 75 VDC	3.3 V @ 0.6 A	0.94" x 0.54" x 0.31" (23.8 x 13.7 x 8) SMT	1500 VDC	75%	ATA00F36S-L
	18 to 75 VDC	5 V @ 0.6 A	0.94" x 0.54" x 0.31" (23.8 x 13.7 x 8)	1500 VDC	78%	ATA00A36-L
	18 to 75 VDC	5 V @ 0.6 A	0.94" x 0.54" x 0.31" (23.8 x 13.7 x 8) SMT	1500 VDC	78%	ATA00A36S-L
	18 to 75 VDC	12 V @ 0.25 A	0.94" x 0.54" x 0.31" (23.8 x 13.7 x 8)	1500 VDC	80%	ATA00B36-L
	18 to 75 VDC	12 V @ 0.25 A	0.94" x 0.54" x 0.31" (23.8 x 13.7 x 8) SMT	1500 VDC	80%	ATA00B36S-L
	18 to 75 VDC	15 V @ 0.2 A	0.94" x 0.54" x 0.31" (23.8 x 13.7 x 8)	1500 VDC	80%	ATA00C36-L
	18 to 75 VDC	15 V @ 0.2 A	0.94" x 0.54" x 0.31" (23.8 x 13.7 x 8) SMT	1500 VDC	80%	ATA00C36S-L
	18 to 75 VDC	24 V @ 0.125 A	0.94" x 0.54" x 0.31" (23.8 x 13.7 x 8)	1500 VDC	80%	ATA00H36-L
	18 to 75 VDC	24 V @ 0.125 A	0.94" x 0.54" x 0.31" (23.8 x 13.7 x 8) SMT	1500 VDC	80%	ATA00H36S-L
	18 to 75 VDC	±5 V @ 0.3 A	0.94" x 0.54" x 0.31" (23.8 x 13.7 x 8)	1500 VDC	77%	ATA00AA36-L
	18 to 75 VDC	±5 V @ 0.3 A	0.94" x 0.54" x 0.31" (23.8 x 13.7 x 8) SMT	1500 VDC	77%	ATA00AA36S-L
	18 to 75 VDC	±12 V @ 0.125 A	0.94" x 0.54" x 0.31" (23.8 x 13.7 x 8)	1500 VDC	80%	ATA00BB36-L
	18 to 75 VDC	±12 V @ 0.125 A	0.94" x 0.54" x 0.31" (23.8 x 13.7 x 8) SMT	1500 VDC	80%	ATA00BB36S-L
	18 to 75 VDC	±15 V @ 0.1 A	0.94" x 0.54" x 0.31" (23.8 x 13.7 x 8)	1500 VDC	80%	ATA00CC36-L
	18 to 75 VDC	±15 V @ 0.1 A	0.94" x 0.54" x 0.31" (23.8 x 13.7 x 8) SMT	1500 VDC	80%	ATA00CC36S-L
	36 to 75 VDC	3.3 V @ 0.6 A	0.55" x 0.55" x 0.31" (14 x 14 x 8)	1500 VDC	79%	AYA01F48-L
	36 to 75 VDC	5 V @ 0.6 A	0.55" x 0.55" x 0.31" (14 x 14 x 8)	1500 VDC	82%	AYA01A48-L
	36 to 75 VDC	12 V @ 0.25 A	0.55" x 0.55" x 0.31" (14 x 14 x 8)	1500 VDC	86%	AYA01B48-L
	36 to 75 VDC	15 V @ 0.2 A	0.55" x 0.55" x 0.31" (14 x 14 x 8)	1500 VDC	86%	AYA01C48-L
	36 to 75 VDC	±5 V @ 0.3 A	0.55" x 0.55" x 0.31" (14 x 14 x 8)	1500 VDC	82%	AYA01AA48-L
	36 to 75 VDC	±12 V @ 0.125 A	0.55" x 0.55" x 0.31" (14 x 14 x 8)	1500 VDC	85%	AYA01BB48-L
	36 to 75 VDC	±15 V @ 0.1 A	0.55" x 0.55" x 0.31" (14 x 14 x 8)	1500 VDC	85%	AYA01CC48-L

## LOW POWER ISOLATED DC-DC PRODUCT

Low Power Isolated DC-DC							
	Input Voltage	Output Voltage	Package L x W x H (mm)	I/O Isolation	Efficiency	Model Number	
6 W	<b>Enclosed</b>						
	9 to 36 VDC	3.3 V @ 1.2 A	0.942" x 0.54" x 0.31" (23.8 x 13.7 x 8)	1500 VDC	78%	ATA01F18-L	
	9 to 36 VDC	3.3 V @ 1.2 A	DIP 1.25" x 0.8" x 0.4" (31.75 x 20.32 x 10.16)	1500 VDC	78%	ASA01F18-LS	
	9 to 36 VDC	5 V @ 1 A	DIP 1.25" x 0.8" x 0.4" (31.75 x 20.32 x 10.16)	1500 VDC	81%	ASA01A18-LS	
	9 to 36 VDC	5 V @ 1.2 A	0.942" x 0.54" x 0.31" (23.8 x 13.7 x 8)	1500 VDC	82%	ATA01A18-L	
	9 to 36 VDC	5 V @ ±0.5 A	DIP 1.25" x 0.8" x 0.4" (31.75 x 20.32 x 10.16)	1500 VDC	81%	ASA00AA18-LS	
	9 to 36 VDC	15 V @ 0.4 A	DIP 1.25" x 0.8" x 0.4" (31.75 x 20.32 x 10.16)	1500 VDC	83%	ASA00C18-LS	
	9 to 36 VDC	12 V @ 0.5 A	0.942" x 0.54" x 0.31" (23.8 x 13.7 x 8)	1500 VDC	85%	ATA01B18-L	
	9 to 36 VDC	12 V @ 0.5 A	DIP 1.25" x 0.8" x 0.4" (31.75 x 20.32 x 10.16)	1500 VDC	82%	ASA00B18-LS	
	9 to 36 VDC	12 V @ ±0.25 A	DIP 1.25" x 0.8" x 0.4" (31.75 x 20.32 x 10.16)	1500 VDC	82%	ASA00BB18-LS	
	9 to 36 VDC	15 V @ 0.4 A	0.942" x 0.54" x 0.31" (23.8 x 13.7 x 8)	1500 VDC	85%	ATA01C18-L	
	9 to 36 VDC	15 V @ ±0.2 A	DIP 1.25" x 0.8" x 0.4" (31.75 x 20.32 x 10.16)	1500 VDC	83%	ASA00CC18-LS	
	9 to 36 VDC	24 V @ 0.25 A	0.942" x 0.54" x 0.31" (23.8 x 13.7 x 8)	1500 VDC	86%	ATA01H18-L	
	9 to 36 VDC	±12 V @ 0.25 A	0.942" x 0.54" x 0.31" (23.8 x 13.7 x 8)	1500 VDC	85%	ATA01BB18-L	
	9 to 36 VDC	±15 V @ 0.2 A	0.942" x 0.54" x 0.31" (23.8 x 13.7 x 8)	1500 VDC	86%	ATA01CC18-L	
	18 to 75 VDC	3.3 V @ 1.2 A	0.942" x 0.54" x 0.31" (23.8 x 13.7 x 8)	1500 VDC	78%	ATA01F36-L	
	18 to 75 VDC	3.3 V @ 1.2 A	DIP 1.25" x 0.8" x 0.4" (31.75 x 20.32 x 10.16)	1500 VDC	78%	ASA01F36-LS	
	18 to 75 VDC	5 V @ 1 A	DIP 1.25" x 0.8" x 0.4" (31.75 x 20.32 x 10.16)	1500 VDC	81%	ASA01A36-LS	
	18 to 75 VDC	5 V @ 1.2 A	0.942" x 0.54" x 0.31" (23.8 x 13.7 x 8)	1500 VDC	82%	ATA01A36-L	
	18 to 75 VDC	5 V @ ±0.5 A	DIP 1.25" x 0.8" x 0.4" (31.75 x 20.32 x 10.16)	1500 VDC	81%	ASA00AA36-LS	
	18 to 75 VDC	12 V @ 0.5 A	0.942" x 0.54" x 0.31" (23.8 x 13.7 x 8)	1500 VDC	85%	ATA01B36-L	
	18 to 75 VDC	12 V @ 0.5 A	DIP 1.25" x 0.8" x 0.4" (31.75 x 20.32 x 10.16)	1500 VDC	82%	ASA00B36-LS	
	18 to 75 VDC	12 V @ ±0.25 A	DIP 1.25" x 0.8" x 0.4" (31.75 x 20.32 x 10.16)	1500 VDC	82%	ASA00BB36-LS	
	18 to 75 VDC	15 V @ 0.4 A	0.942" x 0.54" x 0.31" (23.8 x 13.7 x 8)	1500 VDC	85%	ATA01C36-L	
	18 to 75 VDC	15 V @ 0.4 A	DIP 1.25" x 0.8" x 0.4" (31.75 x 20.32 x 10.16)	1500 VDC	83%	ASA00C36-LS	
	18 to 75 VDC	15 V @ ±0.2 A	DIP 1.25" x 0.8" x 0.4" (31.75 x 20.32 x 10.16)	1500 VDC	83%	ASA00CC36-LS	
	18 to 75 VDC	24 V @ 0.25 A	0.942" x 0.54" x 0.31" (23.8 x 13.7 x 8)	1500 VDC	86%	ATA01H36-L	
	18 to 75 VDC	±12 V @ 0.25 A	0.942" x 0.54" x 0.31" (23.8 x 13.7 x 8)	1500 VDC	85%	ATA01BB36-L	
	18 to 75 VDC	±15 V @ 0.2 A	0.942" x 0.54" x 0.31" (23.8 x 13.7 x 8)	1500 VDC	86%	ATA01CC36-L	
	8 W	<b>Enclosed</b>					
		9 to 36 VDC	3.3 V @ 2 A	0.942" x 0.54" x 0.31" (23.8 x 13.7 x 8)	1500 VDC	78%	ATA02F18-L
		9 to 36 VDC	5 V @ 1.6 A	0.942" x 0.54" x 0.31" (23.8 x 13.7 x 8)	1500 VDC	82%	ATA02A18-L
9 to 36 VDC		12 V @ 0.665 A	0.942" x 0.54" x 0.31" (23.8 x 13.7 x 8)	1500 VDC	85%	ATA02B18-L	
9 to 36 VDC		15 V @ 0.535 A	0.942" x 0.54" x 0.31" (23.8 x 13.7 x 8)	1500 VDC	85%	ATA02C18-L	
9 to 36 VDC		24 V @ 0.335 A	0.942" x 0.54" x 0.31" (23.8 x 13.7 x 8)	1500 VDC	86%	ATA02H18-L	
9 to 36 VDC		±12 V @ 0.335 A	0.942" x 0.54" x 0.31" (23.8 x 13.7 x 8)	1500 VDC	85%	ATA02BB18-L	
9 to 36 VDC		±15 V @ 0.265 A	0.942" x 0.54" x 0.31" (23.8 x 13.7 x 8)	1500 VDC	86%	ATA02CC18-L	
18 to 75 VDC		3.3 V @ 2 A	0.942" x 0.54" x 0.31" (23.8 x 13.7 x 8)	1500 VDC	78%	ATA02F36-L	
18 to 75 VDC		5 V @ 1.6 A	0.942" x 0.54" x 0.31" (23.8 x 13.7 x 8)	1500 VDC	82%	ATA02A36-L	
18 to 75 VDC		12 V @ 0.665 A	0.942" x 0.54" x 0.31" (23.8 x 13.7 x 8)	1500 VDC	85%	ATA02B36-L	
18 to 75 VDC		15 V @ 0.535 A	0.942" x 0.54" x 0.31" (23.8 x 13.7 x 8)	1500 VDC	85%	ATA02C36-L	
18 to 75 VDC		24 V @ 0.335 A	0.942" x 0.54" x 0.31" (23.8 x 13.7 x 8)	1500 VDC	86%	ATA02H36-L	
18 to 75 VDC		±12 V @ 0.335 A	0.942" x 0.54" x 0.31" (23.8 x 13.7 x 8)	1500 VDC	85%	ATA02BB36-L	
18 to 75 VDC		±15 V @ 0.265 A	0.942" x 0.54" x 0.31" (23.8 x 13.7 x 8)	1500 VDC	86%	ATA02CC36-L	

Low Power Isolated DC-DC						
	Input Voltage	Output Voltage	Package L x W x H (mm)	I/O Isolation	Efficiency	Model Number
<b>10 W</b>	<b>Enclosed</b>					
	9 to 36 VDC	3.3 V @ 2.2 A	1" x 1" x 0.4" (25.4 x 25.4 x 10.16)	1500 VDC	86%	AXA02F18-L
	9 to 36 VDC	3.3 V @ 2.7 A	0.942" x 0.54" x 0.31" (23.8 x 13.7 x 8)	1500 VDC	80%	ATA03F18-L
	9 to 36 VDC	5 V @ 2 A	0.942" x 0.54" x 0.31" (23.8 x 13.7 x 8)	1500 VDC	87%	ATA03B18-L
	9 to 36 VDC	5 V @ 2 A	1" x 1" x 0.4" (25.4 x 25.4 x 10.16)	1500 VDC	84%	AXA02A18-L
	9 to 36 VDC	12 V @ 0.83 A	1" x 1" x 0.4" (25.4 x 25.4 x 10.16)	1500 VDC	86%	AXA00B18-L
	9 to 36 VDC	12 V @ 0.833 A	0.942" x 0.54" x 0.31" (23.8 x 13.7 x 8)	1500 VDC	88%	ATA03H18-L
	9 to 36 VDC	15 V @ 0.66 A	1" x 1" x 0.4" (25.4 x 25.4 x 10.16)	1500 VDC	87%	AXA00C18-L
	9 to 36 VDC	15 V @ 0.666 A	0.942" x 0.54" x 0.31" (23.8 x 13.7 x 8)	1500 VDC	83%	ATA03A36-L
	9 to 36 VDC	24 V @ 0.41 A	1" x 1" x 0.4" (25.4 x 25.4 x 10.16)	1500 VDC	86%	AXA000H18-L
	9 to 36 VDC	24 V @ 0.416 A	0.942" x 0.54" x 0.31" (23.8 x 13.7 x 8)	1500 VDC	87%	ATA03BB36-L
	9 to 36 VDC	±5 V @ ±1 A	1" x 1" x 0.4" (25.4 x 25.4 x 10.16)	1500 VDC	84%	AXA00AA18-L
	9 to 36 VDC	±12 V @ 0.416 A	0.942" x 0.54" x 0.31" (23.8 x 13.7 x 8)	1500 VDC	87%	ATA03CC18-L
	9 to 36 VDC	±12 V @ ±0.41 A	1" x 1" x 0.4" (25.4 x 25.4 x 10.16)	1500 VDC	86%	AXA000BB18-L
	9 to 36 VDC	±15 V @ 0.333 A	0.942" x 0.54" x 0.31" (23.8 x 13.7 x 8)	1500 VDC	88%	ATA03C36-L
	9 to 36 VDC	±15 V @ ±0.33 A	1" x 1" x 0.4" (25.4 x 25.4 x 10.16)	1500 VDC	87%	AXA000CC18-L
	18 to 36 VDC	2.5 V @ 3 A	DIP 1.25" x 0.8" x 0.4" (31.75 x 20.32 x 10.16)	1500 VDC	77%	ASA03G24-LS
	18 to 36 VDC	3.3 V @ 3 A	DIP 1.25" x 0.8" x 0.4" (31.75 x 20.32 x 10.16)	1500 VDC	79%	ASA03F24-LS
	18 to 36 VDC	5 V @ 2 A	DIP 1.25" x 0.8" x 0.4" (31.75 x 20.32 x 10.16)	1500 VDC	82%	ASA02A24-LS
	18 to 36 VDC	12 V @ 0.835 A	DIP 1.25" x 0.8" x 0.4" (31.75 x 20.32 x 10.16)	1500 VDC	83%	ASA00B24-LS
	18 to 75 VDC	3.3 V @ 2.2 A	1" x 1" x 0.4" (25.4 x 25.4 x 10.16)	1500 VDC	86%	AXA02F36-L
	18 to 75 VDC	3.3 V @ 2.7 A	0.942" x 0.54" x 0.31" (23.8 x 13.7 x 8)	1500 VDC	83%	ATA03A18-L
	18 to 75 VDC	5 V @ 2 A	0.942" x 0.54" x 0.31" (23.8 x 13.7 x 8)	1500 VDC	88%	ATA03C18-L
	18 to 75 VDC	5 V @ 2 A	1" x 1" x 0.4" (25.4 x 25.4 x 10.16)	1500 VDC	84%	AXA02A36-L
	18 to 75 VDC	12 V @ 0.83 A	1" x 1" x 0.4" (25.4 x 25.4 x 10.16)	1500 VDC	86%	AXA00B36-L
	18 to 75 VDC	12 V @ 0.833 A	0.942" x 0.54" x 0.31" (23.8 x 13.7 x 8)	1500 VDC	87%	ATA03BB18-L
	18 to 75 VDC	15 V @ 0.66 A	1" x 1" x 0.4" (25.4 x 25.4 x 10.16)	1500 VDC	87%	AXA00C36-L
	18 to 75 VDC	15 V @ 0.666 A	0.942" x 0.54" x 0.31" (23.8 x 13.7 x 8)	1500 VDC	87%	ATA03B36-L
	18 to 75 VDC	24 V @ 0.41 A	1" x 1" x 0.4" (25.4 x 25.4 x 10.16)	1500 VDC	86%	AXA000H36-L
	18 to 75 VDC	24 V @ 0.416 A	0.942" x 0.54" x 0.31" (23.8 x 13.7 x 8)	1500 VDC	87%	ATA03CC36-L
	18 to 75 VDC	±5 V @ ±1 A	1" x 1" x 0.4" (25.4 x 25.4 x 10.16)	1500 VDC	84%	AXA00AA36-L
	18 to 75 VDC	±12 V @ 0.416 A	0.942" x 0.54" x 0.31" (23.8 x 13.7 x 8)	1500 VDC	80%	ATA03F36-L
	18 to 75 VDC	±12 V @ ±0.41 A	1" x 1" x 0.4" (25.4 x 25.4 x 10.16)	1500 VDC	86%	AXA000BB36-L
	18 to 75 VDC	±15 V @ 0.333 A	0.942" x 0.54" x 0.31" (23.8 x 13.7 x 8)	1500 VDC	88%	ATA03H36-L
	18 to 75 VDC	±15 V @ ±0.33 A	1" x 1" x 0.4" (25.4 x 25.4 x 10.16)	1500 VDC	87%	AXA000CC36-L
	36 to 75 VDC	2.5 V @ 3 A	DIP 1.25" x 0.8" x 0.4" (31.75 x 20.32 x 10.16)	1500 VDC	87%	ASA03G48-LS
	36 to 75 VDC	3.3 V @ 3 A	DIP 1.25" x 0.8" x 0.4" (31.75 x 20.32 x 10.16)	1500 VDC	79%	ASA03F48-LS
	36 to 75 VDC	5 V @ 2 A	DIP 1.25" x 0.8" x 0.4" (31.75 x 20.32 x 10.16)	1500 VDC	82%	ASA02A48-LS
	36 to 75 VDC	12 V @ 0.835 A	DIP 1.25" x 0.8" x 0.4" (31.75 x 20.32 x 10.16)	1500 VDC	83%	ASA00B48-LS

## LOW POWER ISOLATED DC-DC PRODUCT

Low Power Isolated DC-DC						
	Input Voltage	Output Voltage	Package L x W x H (mm)	I/O Isolation	Efficiency	Model Number
<b>15 W</b>	<b>Enclosed</b>					
	9 to 36 VDC	3.3 V @ 4 A	1" x 2" x 0.44" (25.4 x 50.8 x 11.30)	1500 VDC	80%	AEE04F18-LS
	9 to 36 VDC	5 V @ 3 A	1" x 2" x 0.44" (25.4 x 50.8 x 11.30)	1500 VDC	84%	AEE03A18-LS
	9 to 36 VDC	12 V @ 1.25 A	1" x 2" x 0.44" (25.4 x 50.8 x 11.30)	1500 VDC	84%	AEE01B18-LS
	9 to 36 VDC	15 V @ 1 A	1" x 2" x 0.44" (25.4 x 50.8 x 11.30)	1500 VDC	84%	AEE01C18-LS
	9 to 36 VDC	5 V @ ±1.5 A	1" x 2" x 0.44" (25.4 x 50.8 x 11.30)	1500 VDC	79%	AEE01AA18-LS
	9 to 36 VDC	12 V @ ±0.625 A	1" x 2" x 0.44" (25.4 x 50.8 x 11.30)	1500 VDC	83%	AEE00BB18-LS
	9 to 36 VDC	15 V @ ±0.5 A	1" x 2" x 0.44" (25.4 x 50.8 x 11.30)	1500 VDC	83%	AEE00CC18-LS
	18 to 75 VDC	3.3 V @ 4 A	1" x 2" x 0.44" (25.4 x 50.8 x 11.30)	1500 VDC	80%	AEE04F36-LS
	18 to 75 VDC	5 V @ 3 A	1" x 2" x 0.44" (25.4 x 50.8 x 11.30)	1500 VDC	84%	AEE03A36-LS
	18 to 75 VDC	12 V @ 1.25 A	1" x 2" x 0.44" (25.4 x 50.8 x 11.30)	1500 VDC	84%	AEE01B36-LS
	18 to 75 VDC	15 V @ 1 A	1" x 2" x 0.44" (25.4 x 50.8 x 11.30)	1500 VDC	84%	AEE01C36-LS
	18 to 75 VDC	5 V @ ±1.5 A	1" x 2" x 0.44" (25.4 x 50.8 x 11.30)	1500 VDC	79%	AEE01AA36-LS
	18 to 75 VDC	12 V @ ±0.625 A	1" x 2" x 0.44" (25.4 x 50.8 x 11.30)	1500 VDC	83%	AEE00BB36-LS
	18 to 75 VDC	15 V @ ±0.5 A	1" x 2" x 0.44" (25.4 x 50.8 x 11.30)	1500 VDC	83%	AEE00CC36-LS
<b>20 W</b>	<b>Isolated</b>					
	9 to 36 VDC	3.3 V @ 4.5 A	1" x 1" x 0.4" (25.4 x 25.4 x 10.16)	1500 VDC	87%	AXA04F18-L
	9 to 36 VDC	5 V @ 4 A	1" x 1" x 0.4" (25.4 x 25.4 x 10.16)	1500 VDC	89%	AXA04A18-L
	9 to 36 VDC	12 V @ 1.67 A	1" x 1" x 0.4" (25.4 x 25.4 x 10.16)	1500 VDC	89%	AXA01B18-L
	9 to 36 VDC	15 V @ 1.33 A	1" x 1" x 0.4" (25.4 x 25.4 x 10.16)	1500 VDC	89%	AXA01C18-L
	9 to 36 VDC	24 V @ 0.835 A	1" x 1" x 0.4" (25.4 x 25.4 x 10.16)	1500 VDC	88%	AXA00H18-L
	9 to 36 VDC	±12 V @ 0.835 A	1" x 1" x 0.4" (25.4 x 25.4 x 10.16)	1500 VDC	89%	AXA00BB18-L
	9 to 36 VDC	±15 V @ 0.67 A	1" x 1" x 0.4" (25.4 x 25.4 x 10.16)	1500 VDC	89%	AXA00CC18-L
	18 to 75 VDC	2.5 V @ 6 A	1.6" x 2" x 0.48" (40.6 x 50.8 x 12.19)	1500 VDC	79%	AET06G36-L
	18 to 75 VDC	3.3 V @ 4.5 A	1" x 1" x 0.4" (25.4 x 25.4 x 10.16)	1500 VDC	88%	AXA04F36-L
	18 to 75 VDC	3.3 V @ 6 A	1.6" x 2" x 0.48" (40.6 x 50.8 x 12.19)	1500 VDC	83%	AET06F36-L
	18 to 75 VDC	5 V @ 4 A	1" x 1" x 0.4" (25.4 x 25.4 x 10.16)	1500 VDC	89%	AXA04A36-L
	18 to 75 VDC	5 V @ 4 A	1.6" x 2" x 0.48" (40.6 x 50.8 x 12.19)	1500 VDC	84%	AET04A36-L
	18 to 75 VDC	5 V @ ±2 A	1.6" x 2" x 0.48" (40.6 x 50.8 x 12.19)	1500 VDC	84%	AET02AA36-L
	18 to 75 VDC	12 V @ 1.67 A	1" x 1" x 0.4" (25.4 x 25.4 x 10.16)	1500 VDC	89%	AXA01B36-L
	18 to 75 VDC	12 V @ 1.67 A	1.6" x 2" x 0.48" (40.6 x 50.8 x 12.19)	1500 VDC	85%	AET01B36-L
	18 to 75 VDC	12 V @ ±0.835 A	1.6" x 2" x 0.48" (40.6 x 50.8 x 12.19)	1500 VDC	85%	AET00BB36-L
	18 to 75 VDC	15 V @ 1.33 A	1" x 1" x 0.4" (25.4 x 25.4 x 10.16)	1500 VDC	89%	AXA01C36-L
	18 to 75 VDC	15 V @ 1.33 A	1.6" x 2" x 0.48" (40.6 x 50.8 x 12.19)	1500 VDC	85%	AET01C36-L
	18 to 75 VDC	15 V @ ±0.665 A	1.6" x 2" x 0.48" (40.6 x 50.8 x 12.19)	1500 VDC	85%	AET00CC36-L
	18 to 75 VDC	24 V @ 0.835 A	1" x 1" x 0.4" (25.4 x 25.4 x 10.16)	1500 VDC	88%	AXA00H36-L
18 to 75 VDC	±12 V @ 0.835 A	1" x 1" x 0.4" (25.4 x 25.4 x 10.16)	1500 VDC	89%	AXA00BB36-L	
18 to 75 VDC	±15 V @ 0.67 A	1" x 1" x 0.4" (25.4 x 25.4 x 10.16)	1500 VDC	89%	AXA00CC36-L	



Low Power Isolated DC-DC						
	Input Voltage	Output Voltage	Package L x W x H (mm)	I/O Isolation	Efficiency	Model Number
20 W	<b>Enclosed</b>					
	9 to 36 VDC	2.5 V @ 6 A	1.6" x 2" x 0.48" (40.6 x 50.8 x 12.19)	1500 VDC	79%	AET06G18-L
	9 to 36 VDC	3.3 V @ 6 A	1.6" x 2" x 0.48" (40.6 x 50.8 x 12.19)	1500 VDC	83%	AET06F18-L
	9 to 36 VDC	5 V @ 4 A	1.6" x 2" x 0.48" (40.6 x 50.8 x 12.19)	1500 VDC	84%	AET04A18-L
	9 to 36 VDC	5 V @ ±2 A	1.6" x 2" x 0.48" (40.6 x 50.8 x 12.19)	1500 VDC	84%	AET02AA18-L
	9 to 36 VDC	12 V @ 1.67 A	1.6" x 2" x 0.48" (40.6 x 50.8 x 12.19)	1500 VDC	85%	AET01B18-L
	9 to 36 VDC	12 V @ ±0.835 A	1.6" x 2" x 0.48" (40.6 x 50.8 x 12.19)	1500 VDC	85%	AET00BB18-L
	9 to 36 VDC	15 V @ 1.33 A	1.6" x 2" x 0.48" (40.6 x 50.8 x 12.19)	1500 VDC	85%	AET01C18-L
	9 to 36 VDC	15 V @ ±0.665 A	1.6" x 2" x 0.48" (40.6 x 50.8 x 12.19)	1500 VDC	85%	AET00CC18-L
25 W	<b>Enclosed</b>					
	9 to 36 VDC	3.3 V @ 6 A	1" x 1" x 0.4" (25.4 x 25.4 x 10.16)	1500 VDC	87%	AXA06F18-L
	9 to 36 VDC	5 V @ 5 A	1" x 1" x 0.4" (25.4 x 25.4 x 10.16)	1500 VDC	89%	AXA05A18-L
	9 to 36 VDC	12 V @ 2.09 A	1" x 1" x 0.4" (25.4 x 25.4 x 10.16)	1500 VDC	89%	AXA02B18-L
	9 to 36 VDC	15 V @ 1.67 A	1" x 1" x 0.4" (25.4 x 25.4 x 10.16)	1500 VDC	90%	AXA02C18-L
	9 to 36 VDC	±12 V @ 1.04 A	1" x 1" x 0.4" (25.4 x 25.4 x 10.16)	1500 VDC	89%	AXA01BB18-L
	9 to 36 VDC	±15 V @ 0.84 A	1" x 1" x 0.4" (25.4 x 25.4 x 10.16)	1500 VDC	89%	AXA01CC18-L
	18 to 75 VDC	3.3 V @ 6 A	1" x 1" x 0.4" (25.4 x 25.4 x 10.16)	1500 VDC	88%	AXA06F36-L
	18 to 75 VDC	5 V @ 5 A	1" x 1" x 0.4" (25.4 x 25.4 x 10.16)	1500 VDC	90%	AXA05A36-L
	18 to 75 VDC	12 V @ 2.09 A	1" x 1" x 0.4" (25.4 x 25.4 x 10.16)	1500 VDC	90%	AXA02B36-L
	18 to 75 VDC	15 V @ 1.67 A	1" x 1" x 0.4" (25.4 x 25.4 x 10.16)	1500 VDC	90%	AXA02C36-L
	18 to 75 VDC	±12 V @ 1.04 A	1" x 1" x 0.4" (25.4 x 25.4 x 10.16)	1500 VDC	89%	AXA01BB36-L
	18 to 75 VDC	±15 V @ 0.84 A	1" x 1" x 0.4" (25.4 x 25.4 x 10.16)	1500 VDC	89%	AXA01CC36-L
30 W	<b>Enclosed</b>					
	9 to 36 VDC	2.5 V @ 8 A	1.6" x 2" x 0.48" (40.6 x 50.8 x 12.19)	1500 VDC	79%	AET08G18-L
	9 to 36 VDC	3.3 V @ 7 A	1.6" x 2" x 0.48" (40.6 x 50.8 x 12.19)	1500 VDC	82%	AET07F18-L
	9 to 36 VDC	5 V @ 6 A	1.6" x 2" x 0.48" (40.6 x 50.8 x 12.19)	1500 VDC	84%	AET06A18-L
	9 to 36 VDC	12 V @ 2.5 A	1.6" x 2" x 0.48" (40.6 x 50.8 x 12.19)	1500 VDC	85%	AET02B18-L
	9 to 36 VDC	15 V @ 2 A	1.6" x 2" x 0.48" (40.6 x 50.8 x 12.19)	1500 VDC	85%	AET02C18-L
	9 to 36 VDC	12 V @ ±1.25 A	1.6" x 2" x 0.48" (40.6 x 50.8 x 12.19)	1500 VDC	85%	AET01BB18-L
	9 to 36 VDC	15 V @ ±1 A	1.6" x 2" x 0.48" (40.6 x 50.8 x 12.19)	1500 VDC	85%	AET01CC18-L
	18 to 75 VDC	2.5 V @ 8 A	1.6" x 2" x 0.48" (40.6 x 50.8 x 12.19)	1500 VDC	79%	AET08G36-L
	18 to 75 VDC	3.3 V @ 7 A	1.6" x 2" x 0.48" (40.6 x 50.8 x 12.19)	1500 VDC	82%	AET07F36-L
	18 to 75 VDC	5 V @ 6 A	1.6" x 2" x 0.48" (40.6 x 50.8 x 12.19)	1500 VDC	84%	AET06A36-L
	18 to 75 VDC	12 V @ 2.5 A	1.6" x 2" x 0.48" (40.6 x 50.8 x 12.19)	1500 VDC	85%	AET02B36-L
	18 to 75 VDC	15 V @ 2 A	1.6" x 2" x 0.48" (40.6 x 50.8 x 12.19)	1500 VDC	85%	AET02C36-L
	18 to 75 VDC	12 V @ ±1.25 A	1.6" x 2" x 0.48" (40.6 x 50.8 x 12.19)	1500 VDC	85%	AET01BB36-L
	18 to 75 VDC	15 V @ ±1 A	1.6" x 2" x 0.48" (40.6 x 50.8 x 12.19)	1500 VDC	85%	AET01CC36-L

## LOW POWER ISOLATED DC-DC PRODUCT

Low Power Isolated DC-DC						
	Input Voltage	Output Voltage	Package L x W x H (mm)	I/O Isolation	Efficiency	Model Number
<b>40 W</b>	<b>Enclosed</b>					
	9 to 36 VDC	3.3 V @ 8 A	2" X 1" X 0.4" (25.4 X 50.8 X 10.2)	1500 VDC	89%	AEE08F18-L
	9 to 36 VDC	5 V @ 8 A	2" X 1" X 0.4" (25.4 X 50.8 X 10.2)	1500 VDC	90%	AEE08A18-L
	9 to 36 VDC	12 V @ 3.33 A	2" X 1" X 0.4" (25.4 X 50.8 X 10.2)	1500 VDC	89%	AEE03B18-L
	9 to 36 VDC	15 V @ 2.67 A	2" X 1" X 0.4" (25.4 X 50.8 X 10.2)	1500 VDC	89%	AEE02C18-L
	9 to 36 VDC	24 V @ 1.67 A	2" X 1" X 0.4" (25.4 X 50.8 X 10.2)	1500 VDC	91%	AEE01H18-L
	9 to 36 VDC	±12 V @ 1.67 A	2" X 1" X 0.4" (25.4 X 50.8 X 10.2)	1500 VDC	88%	AEE01BB18-L
	9 to 36 VDC	±15 V @ 1.67 A	2" X 1" X 0.4" (25.4 X 50.8 X 10.2)	1500 VDC	88%	AEE01CC18-L
	18 to 75 VDC	3.3 V @ 8 A	2" X 1" X 0.4" (25.4 X 50.8 X 10.2)	1500 VDC	89%	AEE08F36-L
	18 to 75 VDC	5 V @ 8 A	2" X 1" X 0.4" (25.4 X 50.8 X 10.2)	1500 VDC	90%	AEE08A36-L
	18 to 75 VDC	12 V @ 3.33 A	2" X 1" X 0.4" (25.4 X 50.8 X 10.2)	1500 VDC	90%	AEE03B36-L
	18 to 75 VDC	15 V @ 2.67 A	2" X 1" X 0.4" (25.4 X 50.8 X 10.2)	1500 VDC	90%	AEE02C36-L
	18 to 75 VDC	24 V @ 1.67 A	2" X 1" X 0.4" (25.4 X 50.8 X 10.2)	1500 VDC	91%	AEE01H36-L
	18 to 75 VDC	±12 V @ 1.67 A	2" X 1" X 0.4" (25.4 X 50.8 X 10.2)	1500 VDC	88%	AEE01BB36-L
	18 to 75 VDC	±15 V @ 1.67 A	2" X 1" X 0.4" (25.4 X 50.8 X 10.2)	1500 VDC	88%	AEE01CC36-L
<b>50 W</b>	<b>Enclosed</b>					
	9 to 36 VDC	3.3 V @ 10 A	2" X 1" X 0.4" (25.4 X 50.8 X 10.2)	1500 VDC	90%	AEE10F18-L
	9 to 36 VDC	5 V @ 10 A	2" X 1" X 0.4" (25.4 X 50.8 X 10.2)	1500 VDC	91%	AEE10A18-L
	9 to 36 VDC	12 V @ 4.17 A	2" X 1" X 0.4" (25.4 X 50.8 X 10.2)	1500 VDC	92%	AEE04B18-L
	9 to 36 VDC	15 V @ 3.33 A	2" X 1" X 0.4" (25.4 X 50.8 X 10.2)	1500 VDC	92%	AEE03C18-L
	9 to 36 VDC	24 V @ 2.08 A	2" X 1" X 0.4" (25.4 X 50.8 X 10.2)	1500 VDC	91%	AEE02H18-L
	18 to 75 VDC	3.3 V @ 10 A	2" X 1" X 0.4" (25.4 X 50.8 X 10.2)	1500 VDC	90%	AEE10F36-L
	18 to 75 VDC	5 V @ 10 A	2" X 1" X 0.4" (25.4 X 50.8 X 10.2)	1500 VDC	91%	AEE10A36-L
	18 to 75 VDC	12 V @ 4.17 A	2" X 1" X 0.4" (25.4 X 50.8 X 10.2)	1500 VDC	92%	AEE04B36-L
	18 to 75 VDC	15 V @ 3.33 A	2" X 1" X 0.4" (25.4 X 50.8 X 10.2)	1500 VDC	92%	AEE03C36-L
	18 to 75 VDC	24 V @ 2.08 A	2" X 1" X 0.4" (25.4 X 50.8 X 10.2)	1500 VDC	91%	AEE02H36-L

# DC-DC Converter for Railway Applications



ERM40W

DC-DC Converter for Railway Applications						
	Input Voltage	Output	Package (mm)	I/O Isolation	Efficiency	Model Number
10 W	24 (9 to 36 V)	5 V @ 2 A	2" x 1" x 0.43" (50.8 x 25.4 x 11)	3000 VAC rms	84%	ERM02A18
	24 (9 to 36 V)	12 V @ 0.83 A	2" x 1" x 0.43" (50.8 x 25.4 x 11)	3000 VAC rms	86%	ERM00B18
	24 (9 to 36 V)	15 V @ 0.67 A	2" x 1" x 0.43" (50.8 x 25.4 x 11)	3000 VAC rms	86%	ERM00C18
	24 (9 to 36 V)	24 V @ 0.41 A	2" x 1" x 0.43" (50.8 x 25.4 x 11)	3000 VAC rms	85%	ERM00H18
	24 (9 to 36 V)	±12 V @ 0.417 A	2" x 1" x 0.43" (50.8 x 25.4 x 11)	3000 VAC rms	86%	ERM00BB18
	24 (9 to 36 V)	±15 V @ 0.335 A	2" x 1" x 0.43" (50.8 x 25.4 x 11)	3000 VAC rms	87%	ERM00CC18
	48 (18 to 75 V)	5 V @ 2 A	2" x 1" x 0.43" (50.8 x 25.4 x 11)	3000 VAC rms	84%	ERM02A36
	48 (18 to 75 V)	12 V @ 0.83 A	2" x 1" x 0.43" (50.8 x 25.4 x 11)	3000 VAC rms	86%	ERM00B36
	48 (18 to 75 V)	15 V @ 0.67 A	2" x 1" x 0.43" (50.8 x 25.4 x 11)	3000 VAC rms	86%	ERM00C36
	48 (18 to 75 V)	24 V @ 0.41 A	2" x 1" x 0.43" (50.8 x 25.4 x 11)	3000 VAC rms	85%	ERM00H36
	48 (18 to 75 V)	±12 V @ 0.417 A	2" x 1" x 0.43" (50.8 x 25.4 x 11)	3000 VAC rms	89%	ERM00BB36
	48 (18 to 75 V)	±15 V @ 0.335 A	2" x 1" x 0.43" (50.8 x 25.4 x 11)	3000 VAC rms	88%	ERM00CC36
	72, 110 (40 to 160 V)	5 V @ 2 A	2" x 1" x 0.43" (50.8 x 25.4 x 11)	3000 VAC rms	82%	ERM02A110
	72, 110 (40 to 160 V)	12 V @ 0.83 A	2" x 1" x 0.43" (50.8 x 25.4 x 11)	3000 VAC rms	85%	ERM00B110
	72, 110 (40 to 160 V)	15 V @ 0.67 A	2" x 1" x 0.43" (50.8 x 25.4 x 11)	3000 VAC rms	85%	ERM00C110
	72, 110 (40 to 160 V)	24 V @ 0.41 A	2" x 1" x 0.43" (50.8 x 25.4 x 11)	3000 VAC rms	84%	ERM00H110
72, 110 (40 to 160 V)	±12 V @ 0.417 A	2" x 1" x 0.43" (50.8 x 25.4 x 11)	3000 VAC rms	86%	ERM00BB110	
72, 110 (40 to 160 V)	±15 V @ 0.335 A	2" x 1" x 0.43" (50.8 x 25.4 x 11)	3000 VAC rms	86%	ERM00CC110	
20 W	24 (9 to 36 V)	5 V @ 4 A	2" x 1" x 0.43" (50.8 x 25.4 x 11)	3000 VAC rms	85%	ERM04A18
	24 (9 to 36 V)	12 V @ 1.67 A	2" x 1" x 0.43" (50.8 x 25.4 x 11)	3000 VAC rms	87%	ERM01B18
	24 (9 to 36 V)	15 V @ 1.33 A	2" x 1" x 0.43" (50.8 x 25.4 x 11)	3000 VAC rms	87%	ERM01C18
	24 (9 to 36 V)	24 V @ 0.833 A	2" x 1" x 0.43" (50.8 x 25.4 x 11)	3000 VAC rms	86%	ERM01H18
	24 (9 to 36 V)	±12 V @ 0.833 A	2" x 1" x 0.43" (50.8 x 25.4 x 11)	3000 VAC rms	86%	ERM01BB18
	24 (9 to 36 V)	±15 V @ 0.667 A	2" x 1" x 0.43" (50.8 x 25.4 x 11)	3000 VAC rms	86%	ERM01CC18
	48 (18 to 75 V)	5 V @ 4 A	2" x 1" x 0.43" (50.8 x 25.4 x 11)	3000 VAC rms	85%	ERM04A36
	48 (18 to 75 V)	12 V @ 1.67 A	2" x 1" x 0.43" (50.8 x 25.4 x 11)	3000 VAC rms	87%	ERM01B36
	48 (18 to 75 V)	15 V @ 1.33 A	2" x 1" x 0.43" (50.8 x 25.4 x 11)	3000 VAC rms	87%	ERM01C36
	48 (18 to 75 V)	24 V @ 0.833 A	2" x 1" x 0.43" (50.8 x 25.4 x 11)	3000 VAC rms	86%	ERM01H36
	48 (18 to 75 V)	±12 V @ 0.833 A	2" x 1" x 0.43" (50.8 x 25.4 x 11)	3000 VAC rms	87%	ERM01BB36
	48 (18 to 75 V)	±15 V @ 0.667 A	2" x 1" x 0.43" (50.8 x 25.4 x 11)	3000 VAC rms	86%	ERM01CC36
	72, 110 (40 to 160 V)	5 V @ 4 A	2" x 1" x 0.43" (50.8 x 25.4 x 11)	3000 VAC rms	83%	ERM04A110
	72, 110 (40 to 160 V)	12 V @ 1.67 A	2" x 1" x 0.43" (50.8 x 25.4 x 11)	3000 VAC rms	86%	ERM01B110
	72, 110 (40 to 160 V)	15 V @ 1.33 A	2" x 1" x 0.43" (50.8 x 25.4 x 11)	3000 VAC rms	86%	ERM01C110
	72, 110 (40 to 160 V)	24 V @ 0.833 A	2" x 1" x 0.43" (50.8 x 25.4 x 11)	3000 VAC rms	85%	ERM01H110
72, 110 (40 to 160 V)	±12 V @ 0.833 A	2" x 1" x 0.43" (50.8 x 25.4 x 11)	3000 VAC rms	86%	ERM01BB110	
72, 110 (40 to 160 V)	±15 V @ 0.667 A	2" x 1" x 0.43" (50.8 x 25.4 x 11)	3000 VAC rms	86%	ERM01CC110	

## LOW POWER ISOLATED DC-DC PRODUCT

DC-DC Converter for Railway Applications						
	Input Voltage	Output	Package (mm)	I/O Isolation	Efficiency	Model Number
<b>50 W</b>	72 (43 to 101 V)	5 V @ 10 A	2.28" x 1.45" x 0.5" (57.9 x 36.8 x 12.7)	3000 VAC rms	90%	ERM10A72
	72 (43 to 101 V)	12 V @ 4.17 A	2.28" x 1.45" x 0.5" (57.9 x 36.8 x 12.7)	3000 VAC rms	92%	ERM04B72
	72 (43 to 101 V)	15 V @ 3.33 A	2.28" x 1.45" x 0.5" (57.9 x 36.8 x 12.7)	3000 VAC rms	92%	ERM03C72
	72 (43 to 101 V)	24 V @ 2.08 A	2.28" x 1.45" x 0.5" (57.9 x 36.8 x 12.7)	3000 VAC rms	91%	ERM02H72
	110 (66 to 160 V)	5 V @ 10 A	2.28" x 1.45" x 0.5" (57.9 x 36.8 x 12.7)	3000 VAC rms	90%	ERM10A110
	110 (66 to 160 V)	12 V @ 4.17 A	2.28" x 1.45" x 0.5" (57.9 x 36.8 x 12.7)	3000 VAC rms	91%	ERM04B110
	110 (66 to 160 V)	15 V @ 3.33 A	2.28" x 1.45" x 0.5" (57.9 x 36.8 x 12.7)	3000 VAC rms	92%	ERM03C110
	110 (66 to 160 V)	24 V @ 2.08 A	2.28" x 1.45" x 0.5" (57.9 x 36.8 x 12.7)	3000 VAC rms	91%	ERM02H110
<b>75 W</b>	72 (43 to 101 V)	5 V @ 15 A	2.28" x 1.45" x 0.5" (57.9 x 36.8 x 12.7)	3000 VAC rms	89%	ERM15A72
	72 (43 to 101 V)	12 V @ 6.25 A	2.28" x 1.45" x 0.5" (57.9 x 36.8 x 12.7)	3000 VAC rms	92%	ERM06B72
	72 (43 to 101 V)	15 V @ 5 A	2.28" x 1.45" x 0.5" (57.9 x 36.8 x 12.7)	3000 VAC rms	92%	ERM05C72
	72 (43 to 101 V)	24 V @ 3.125 A	2.28" x 1.45" x 0.5" (57.9 x 36.8 x 12.7)	3000 VAC rms	91%	ERM03H72
	110 (66 to 160 V)	5 V @ 15 A	2.28" x 1.45" x 0.5" (57.9 x 36.8 x 12.7)	3000 VAC rms	89%	ERM15A110
	110 (66 to 160 V)	12 V @ 6.25 A	2.28" x 1.45" x 0.5" (57.9 x 36.8 x 12.7)	3000 VAC rms	91%	ERM06B110
	110 (66 to 160 V)	15 V @ 5 A	2.28" x 1.45" x 0.5" (57.9 x 36.8 x 12.7)	3000 VAC rms	91%	ERM05C110
	110 (66 to 160 V)	24 V @ 3.125 A	2.28" x 1.45" x 0.5" (57.9 x 36.8 x 12.7)	3000 VAC rms	90%	ERM03H110

# DC-DC Converter for Medical Applications



## SPECIAL FEATURES

- Medical Safety to UL / CSA / IEC / EN 60601-1 3rd Edition
- 4200 VAC reinforced insulation
- 2 MOOP rated
- Low leakage current
- Operating Temperature Range -40 to +85°C (with derating)
- Input filter meet EN 55022, Class A and FCC, Level A
- 3-year product warranty

DC-DC Converter for Medical Applications							
	Input Voltage	Output 1 Voltage	Output 2 Voltage	Package L x W x H (mm)	I/O Isolation	Efficiency	Model Number
5 W	<b>Enclosed</b>						
	9 to 18 V	5 V @ 1 A		1.25" x 0.8" x 0.41" (31.8 x 20.3 x 10.5)	4200 VAC rms	75%	ASA01A12-M
	18 to 36 V	5 V @ 1 A		1.25" x 0.8" x 0.41" (31.8 x 20.3 x 10.5)	4200 VAC rms	77%	ASA01A24-M
	36 to 75 V	5 V @ 1 A		1.25" x 0.8" x 0.41" (31.8 x 20.3 x 10.5)	4200 VAC rms	77%	ASA01A48-M
6 W	<b>Enclosed</b>						
	9 to 18 V	12 V @ 0.5 A		1.25" x 0.8" x 0.41" (31.8 x 20.3 x 10.5)	4200 VAC rms	78%	ASA01B12-M
	9 to 18 V	12 V @ 0.25 A		1.25" x 0.8" x 0.41" (31.8 x 20.3 x 10.5)	4200 VAC rms	78%	ASA01BB12-M
	9 to 18 V	15 V @ 0.2 A		1.25" x 0.8" x 0.41" (31.8 x 20.3 x 10.5)	4200 VAC rms	78%	ASA01CC12-M
	18 to 36 V	12 V @ 0.5 A		1.25" x 0.8" x 0.41" (31.8 x 20.3 x 10.5)	4200 VAC rms	80%	ASA01B24-M
	18 to 36 V	12 V @ 0.25 A		1.25" x 0.8" x 0.41" (31.8 x 20.3 x 10.5)	4200 VAC rms	80%	ASA01BB24-M
	18 to 36 V	15 V @ 0.2 A		1.25" x 0.8" x 0.41" (31.8 x 20.3 x 10.5)	4200 VAC rms	80%	ASA01CC24-M
	36 to 75 V	12 V @ 0.5 A		1.25" x 0.8" x 0.41" (31.8 x 20.3 x 10.5)	4200 VAC rms	80%	ASA01B48-M
	36 to 75 V	12 V @ 0.25 A		1.25" x 0.8" x 0.41" (31.8 x 20.3 x 10.5)	4200 VAC rms	80%	ASA01BB48-M
36 to 75 V	15 V @ 0.2 A		1.25" x 0.8" x 0.41" (31.8 x 20.3 x 10.5)	4200 VAC rms	80%	ASA01CC48-M	
8 W	9 to 18 V	5 V @ 1.6 A		2" x 1" x 0.4" (50.8 x 25.4 x 10.2)	4200 VAC rms	76%	AEE01A12-M

# DC-DC Converter for Medical Applications

Medical Safety to UL / CSA / IEC / EN 60601-1  
3rd Edition

AEE15W



DC-DC Converter for Medical Applications							
	Input Voltage	Output 1 Voltage	Output 2 Voltage	Package L x W x H (mm)	I/O Isolation	Efficiency	Model Number
<b>15 W</b>	<b>Enclosed</b>						
	9 to 18 V	5 V @ 3 A		2" x 1" x 0.47" (50.8 x 25.4 x 12)	4200 VAC rms	85%	AEE03A12-M
	9 to 18 V	12 V @ 1.25 A		2" x 1" x 0.47" (50.8 x 25.4 x 12)	4200 VAC rms	89%	AEE01B12-M
	9 to 18 V	15 V @ 1 A		2" x 1" x 0.47" (50.8 x 25.4 x 12)	4200 VAC rms	88%	AEE01C12-M
	9 to 18 V	24 V @ 0.625 A		2" x 1" x 0.47" (50.8 x 25.4 x 12)	4200 VAC rms	88%	AEE01H12-M
	9 to 18 V	12 V @ 0.625 A	-12 V @ 0.625 A	2" x 1" x 0.47" (50.8 x 25.4 x 12)	4200 VAC rms	88%	AEE01BB12-M
	9 to 18 V	15 V @ 0.5 A	-15 V @ 0.5 A	2" x 1" x 0.47" (50.8 x 25.4 x 12)	4200 VAC rms	89%	AEE01CC12-M
	18 to 36 V	5 V @ 3 A		2" x 1" x 0.47" (50.8 x 25.4 x 12)	4200 VAC rms	87%	AEE03A24-M
	18 to 36 V	12 V @ 1.25 A		2" x 1" x 0.47" (50.8 x 25.4 x 12)	4200 VAC rms	89%	AEE01B24-M
	18 to 36 V	15 V @ 1 A		2" x 1" x 0.47" (50.8 x 25.4 x 12)	4200 VAC rms	88%	AEE01C24-M
	18 to 36 V	24 V @ 0.625 A		2" x 1" x 0.47" (50.8 x 25.4 x 12)	4200 VAC rms	90%	AEE01H24-M
	18 to 36 V	12 V @ 0.625 A	-12 V @ 0.625 A	2" x 1" x 0.47" (50.8 x 25.4 x 12)	4200 VAC rms	90%	AEE01BB24-M
	18 to 36 V	15 V @ 0.5 A	-15 V @ 0.5 A	2" x 1" x 0.47" (50.8 x 25.4 x 12)	4200 VAC rms	89%	AEE01CC24-M
	36 to 75 V	5 V @ 3 A		2" x 1" x 0.47" (50.8 x 25.4 x 12)	4200 VAC rms	88%	AEE03A48-M
	36 to 75 V	12 V @ 1.25 A		2" x 1" x 0.47" (50.8 x 25.4 x 12)	4200 VAC rms	88%	AEE01B48-M
	36 to 75 V	15 V @ 1 A		2" x 1" x 0.47" (50.8 x 25.4 x 12)	4200 VAC rms	87%	AEE01C48-M
	36 to 75 V	24 V @ 0.625 A		2" x 1" x 0.47" (50.8 x 25.4 x 12)	4200 VAC rms	88%	AEE01H48-M
	<b>20 W</b>	9 to 18 V	5 V @ 4 A		2" x 1" x 0.47" (50.8 x 25.4 x 12)	4200 VAC rms	85%
9 to 18 V		12 V @ 1.67 A		2" x 1" x 0.47" (50.8 x 25.4 x 12)	4200 VAC rms	89%	AEE02B12-M
9 to 18 V		15 V @ 1.33 A		2" x 1" x 0.47" (50.8 x 25.4 x 12)	4200 VAC rms	88%	AEE02C12-M
9 to 18 V		24 V @ 0.84 A		2" x 1" x 0.47" (50.8 x 25.4 x 12)	4200 VAC rms	89%	AEE02H12-M
9 to 18 V		12 V @ 0.84 A	-12 V @ 0.84 A	2" x 1" x 0.47" (50.8 x 25.4 x 12)	4200 VAC rms	89%	AEE02BB12-M
9 to 18 V		15 V @ 0.67 A	-15 V @ 0.67 A	2" x 1" x 0.47" (50.8 x 25.4 x 12)	4200 VAC rms	89%	AEE02CC12-M
18 to 36 V		5 V @ 4 A		2" x 1" x 0.47" (50.8 x 25.4 x 12)	4200 VAC rms	87%	AEE04A24-M
18 to 36 V		12 V @ 1.67 A		2" x 1" x 0.47" (50.8 x 25.4 x 12)	4200 VAC rms	89%	AEE02B24-M
18 to 36 V		15 V @ 1.33 A		2" x 1" x 0.47" (50.8 x 25.4 x 12)	4200 VAC rms	88%	AEE02C24-M
18 to 36 V		24 V @ 0.84 A		2" x 1" x 0.47" (50.8 x 25.4 x 12)	4200 VAC rms	90%	AEE02H24-M
18 to 36 V		12 V @ 0.84 A	-12 V @ 0.84 A	2" x 1" x 0.47" (50.8 x 25.4 x 12)	4200 VAC rms	90%	AEE02BB24-M
18 to 36 V		15 V @ 0.67 A	-15 V @ 0.67 A	2" x 1" x 0.47" (50.8 x 25.4 x 12)	4200 VAC rms	89%	AEE02CC24-M
36 to 75 V		5 V @ 4 A		2" x 1" x 0.47" (50.8 x 25.4 x 12)	4200 VAC rms	88%	AEE04A48-M
36 to 75 V		12 V @ 1.67 A		2" x 1" x 0.47" (50.8 x 25.4 x 12)	4200 VAC rms	89%	AEE02B48-M
36 to 75 V		15 V @ 1.33 A		2" x 1" x 0.47" (50.8 x 25.4 x 12)	4200 VAC rms	88%	AEE02C48-M
36 to 75 V		24 V @ 0.84 A		2" x 1" x 0.47" (50.8 x 25.4 x 12)	4200 VAC rms	88%	AEE02H48-M
36 to 75 V		12 V @ 0.84 A	-12 V @ 0.84 A	2" x 1" x 0.47" (50.8 x 25.4 x 12)	4200 VAC rms	88%	AEE02BB48-M
36 to 75 V		15 V @ 0.67 A	-15 V @ 0.67 A	2" x 1" x 0.47" (50.8 x 25.4 x 12)	4200 VAC rms	89%	AEE02CC48-M

# Mission-Critical High Voltage Solutions for Demanding Applications

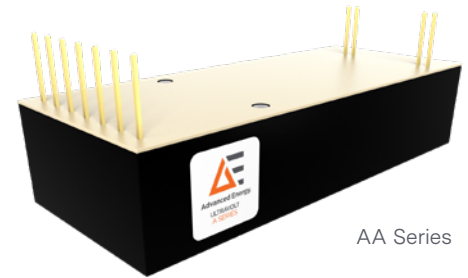

AA Series

## STANDARD, CONFIGURABLE MODULES

- Exceptionally wide input and output operating ranges
- Products to 250 W, paralleled to 1000 W
- Advanced arc handling
- RoHS compliance

## BENEFITS

- Proven solutions, higher reliability
- Lower initial cost
- Excellent power quality
- Shorter lead times, faster integration
- Easy interfacing: digital ready

Mission-Critical High Voltage Solutions for Demanding Applications							
Series	Power (W)	Input Voltage	Output Voltage	Package L x W x H (mm)	I/O Isolation	Model Number (Examples)	Special Features
A Series	4, 15, 20, or 30	12 V on 4 W 24 V on 20, or 30 W	62 V to 40 kV	1/16 to 6 A Series: 94 x 38.1 x 20.7 10 A Series: 94.6 x 38.7 x 24.5 15 A Series: 119.4 x 38.7 x 24.5 20 A Series: 144.8 x 38.7 x 27.4 25 A Series: 176.8 x 40.6 x 27.4 30 A Series: 176.8 x 40.6 x 28.9 35 A Series: 176.8 x 40.6 x 28.9 40 A Series: 202.2 x 40.6 x 35.7	No	1/16A12-P4 40A24-N30	<ul style="list-style-type: none"> <li>■ Configurable high voltage output, power and polarity</li> <li>■ Available 0 to 5 VDC or 0 to 10 VDC (full-scale) analog interfaces</li> <li>■ Control and monitoring of high voltage output and current</li> <li>■ Wide selection of electrical, shielding and mechanical integration options</li> <li>■ Ripple performance as low at 100 ppm</li> </ul>
AA Series	4, 20, or 30	12 V on 4 W 24 V on 20, or 30 W	62 V to 6 kV	75.4 x 38.1 x 20.5	No	1/16AA24-P20 6AA12-N4	<ul style="list-style-type: none"> <li>■ Configurable high voltage output, power, and polarity in a common footprint</li> <li>■ Available 0 to 5 VDC or 0 to 10 VDC (full-scale) analog interfaces</li> <li>■ Control and monitoring of high voltage output and current</li> <li>■ Selection of electrical, shielding, and mechanical integration options</li> <li>■ Ripple performance as low as 100 ppm (0.05 V<sub>pp</sub>)</li> </ul>
C Series	20 or 30	24 V	125 V to 6 kV	94 x 38.1 x 19.6	No	1/8C24-N20 6C24-P30	<ul style="list-style-type: none"> <li>■ Fast-rise charging power delivered from an optimized design</li> <li>■ Limited overshoot, typically less than 1% of high voltage setpoint, depending on the application</li> <li>■ Configurable high-voltage out, power and polarity in a common, compact footprint</li> <li>■ Full-range control and monitoring of high-voltage output and current</li> <li>■ Selection of electrical, shielding and mechanical integration options</li> </ul>
Dual Polarity C Series	125 or 250	24 V	125 V to 6 kV	203.2 x 114.3 x 27.4	No	1/8C24-NP125 6C24-NP250	<ul style="list-style-type: none"> <li>■ Fast-rise charging power delivered from an optimized design</li> <li>■ Limited overshoot, typically less than 1% of high voltage setpoint, depending on the application</li> <li>■ Fully-integrated dual output package</li> <li>■ Full-range control and monitoring of high voltage output and current</li> <li>■ Selection of electrical and mechanical integration options</li> </ul>

## HIGH VOLTAGE POWER SUPPLIES

Mission-Critical High Voltage Solutions for Demanding Applications							
Series	Power (W)	Input Voltage	Output Voltage	Package L x W x H (mm)	I/O Isolation	Model Number (Examples)	Special Features
FIL Series	15	24 V	5 V	119.4 x 38.1 x 22.9	No	FIL-5V-3A	<ul style="list-style-type: none"> <li>Units feature surface-mount technology and encapsulation techniques</li> <li>Maximum output current capability down to 0 volts</li> <li>Capable of providing 0 to 5 VDC and 0 to 3 A</li> <li>Current and voltage mode indicators</li> <li>Units are available with several options</li> </ul>
EFL Series	12,24, or 36	12 V or 24 V	12 V or 24 V	15EFL Series: 144.8 x 38.1 x 33 30EFL Series: 177.6 x 41.3 x 38.1	Yes	15EFL12-12W-I/O-RB 30EFL24-36W-I/O-RB	<ul style="list-style-type: none"> <li>Precision analog control</li> <li>Linearity of <math>\pm 0.05\%</math> and accuracy of <math>\pm 0.2\%</math></li> <li>10ppm temperature coefficient</li> <li>Isolated up to 15 kV or 30 kV</li> <li>Isolation resistance of 150 G<math>\Omega</math> (15 kV) or 2 G<math>\Omega</math> (30 kV)</li> <li>4 regulated floating LV power outputs</li> <li>Isolated digital and analog I/O to and from floating hot deck</li> </ul>
FL Series	12 or 24	12 V or 24 V	12 V or 24 V	144.8 x 38.1 x 29.8	Yes	15FL12-12W	<ul style="list-style-type: none"> <li>Isolated up to 15 kV</li> <li>DC leakage current of &lt;10 nA</li> <li>AC leakage capacitance of &lt;40 pF</li> <li>3 regulated floating LV power outputs</li> <li>Isolated digital I/O to and from floating hot deck</li> <li>Isolated analog I/O to and from floating hot deck</li> <li>UL/cUL Recognized Component; CE Mark (LVD &amp; RoHS)</li> </ul>
High Power C Series	60, 125, 250	24 V	125 V to 60 kV	1/8C to 6C 60&125 W: 114.3 x 101.6 x 27 1/8C to 6C 250 W: 203.2 x 114.3 x 27 8C to 30C 60&125 W: 203.2 x 114.3 x 27 8C to 30C 250 W: 235 x 114.3 x 51.6 40C to 60C: 355.6 x 114.3 x 63.5	No	1/8C24-N125 6C24-P250 8C24-P60 30C24-N125 50C24-P250	<ul style="list-style-type: none"> <li>Fast-rise charging power delivered from an optimized design</li> <li>Limited overshoot, typically less than 1% of high voltage setpoint, depending on the application</li> <li>High power-to-package size ratio</li> <li>Full-featured analog interface includes voltage/current controls and monitors</li> <li>Selection of electrical and mechanical integration options</li> </ul>
HVA	1, 1.5, or 2	24 V	1 kV to 20 kV	Small: 152.4 x 96.8 x 31.8 Large: 247.7 x 165.1 x 38.1	No	1HVA24-P1 20HVA24-BP1	<ul style="list-style-type: none"> <li>Full-range two- and four-quadrant output of voltage and current for bias, amplification or reversing</li> <li>Fast voltage slew rates and broad bandwidths up to 500 Hz</li> <li>Sources and sinks output current through operating range</li> <li>High voltage output controlled using differential analog inputs</li> <li>Compact size with electrical performance and mechanical integration options</li> </ul>
LE Series	4, 15 (10 and 30 only), 20 (1 to 6 only), 30	24 V	1 kV to 30 kV	1-15 kV: 152.4 x 96.77 x 38.15 20-30 kV: 184.91 x 100 x 38.16	No	1LE24-P4 30LE24-N30	<ul style="list-style-type: none"> <li>Low ripple output performance</li> <li>Available temperature coefficient to 25 ppm/<math>^{\circ}</math>C (optional 10 ppm/<math>^{\circ}</math>C 1LE to 15LE only) with line regulation less than 25 ppm</li> <li>High voltage output control via differential analog inputs</li> <li>Full-featured 0 to 10 VDC control; interface includes voltage/current controls and monitors</li> <li>Electrical performance and mechanical integration options</li> </ul>



Mission-Critical High Voltage Solutions for Demanding Applications							
Series	Power (W)	Input Voltage	Output Voltage	Package L x W x H (mm)	I/O Isolation	Model Number (Examples)	Special Features
D Series	1, 2, 4, or 6	15 V or 24 V	1 kV to 6 kV	1 to 4 kV, up to 4 W: 63.5 x 44 x 13 1 to 6 kV, 6 W: 63.5 x 44 x 17.5	No	1D15-N1 6D24-P6	<ul style="list-style-type: none"> <li>■ Small-footprint, PCB-mountable package</li> <li>■ High voltage control and monitoring accuracy better than 0.2%</li> <li>■ Analog interface with integral voltage control and voltage/current monitors</li> <li>■ Over-temperature protection disables output if module case &gt; 75°C</li> <li>■ Reversed polarity, short-circuit/arc, and over-current protection</li> </ul>
M Series	0.5, 0.8, or 1	600 V to 1.5 kV: 12,15, or 24 2 kV to 3 kV: 5, 15, or 24	600 V to 3 kV	47 x 28 x 12.5	No	0.6M0.5-P0.5 3M24-N1	<ul style="list-style-type: none"> <li>■ Low profile, lightweight, PCB-mountable package</li> <li>■ Wide selection of input and output voltage configurations</li> <li>■ Low output ripple, temperature coefficient, and line regulation (Analog interface with integral voltage control and voltage/current monitors)</li> <li>■ Integrated reverse input polarity, short-circuit/arc, and over-current protection</li> </ul>
MPM Series	1.5 W	12 or 24	100 V to 3 kV	38.1 x 38.1 x 20.1	No	MPM12-100N MPM24-3KP	<ul style="list-style-type: none"> <li>■ Single pin provides both module power and control of high voltage output</li> <li>■ Compact, low-profile, PCB-mountable package</li> <li>■ Selection of high voltage outputs: 100 to 3000 VDC, positive or negative polarity</li> <li>■ Input polarity protection; output protection from intermittent open- or short-circuits</li> <li>■ Available input/output isolation to 100 VDC, metal shielding options</li> </ul>
US Series	100 mW	5, 12	200 V to 500 V	25.5 x 20.5 x 11	No	0.5US5-P0.1	<ul style="list-style-type: none"> <li>■ Small, lightweight, PCB-mountable package (5.8 cm<sup>3</sup>, 13 g)</li> <li>■ Low output ripple, temperature coefficient, and line regulation (Analog interface with output voltage control and monitoring)</li> <li>■ Integrated over-current and short circuit/arc protection</li> <li>■ Tin-plated metal enclosure</li> </ul>
V Series	0.5, 0.8, or 1	600 V to 1.5 kV: 12, 15, or 24 2 kV to 3 kV: 5, 15, or 24	600 V to 3 kV	46 x 12 x 24.6	No	0.6V0.5-P0.5 3V24-N1	<ul style="list-style-type: none"> <li>■ Small-footprint, lightweight, PCB-mountable package</li> <li>■ Wide selection of input and output voltage configurations</li> <li>■ Low output ripple, temperature coefficient, and line regulation (Analog interface with integral voltage control and voltage/current monitors)</li> <li>■ Integrated reverse polarity, short-circuit/arc, and overcurrent protection</li> </ul>
XS Series	100 mW	5	100 V	11 x 11 x 10.7	No		<ul style="list-style-type: none"> <li>■ Small, lightweight, PCB-mountable package (1.3 cm<sup>3</sup>; 5 g)</li> <li>■ Output ripple &lt; 100 ppm, with temperature coefficient &lt; 50 ppm/°C</li> <li>■ Analog interface w/ output volt. control</li> <li>■ Integrated overcurrent protection</li> <li>■ Tin-plated metal enclosure</li> </ul>
HV Rack® Series	1 to 4 channels, 250 W per channel, total maximum 1000 W	230 VAC	62 V to 40 kV	482.6 x 470 x 133.35	No	Custom	<ul style="list-style-type: none"> <li>■ Up to four configurable high-voltage outputs</li> <li>■ Ideal for various beam applications</li> <li>■ Can provide floating filament 0 to 5 VDC/0 to 3 Amps when used with the FIL5V-3A</li> <li>■ Current mode and voltage mode indicator</li> <li>■ Several options and unites</li> </ul>

## Rapid Modification and Value-Added Solutions

Time-to-market, reliability and costs have the greatest impact on your ROI. Fully custom solutions can delay your time-to-market and undermine your competitive advantage. Avoid paying custom development costs with an Advanced Energy modified standard power supply.

While Advanced Energy's Artesyn, Excelsys and UltraVolt product lines offer a broad range of standard products that address the needs of many industries, there are occasions when a standard product does not address all your application requirements. A custom solution may not be economical or meet scheduling needs. By using proven standard platforms as building blocks, Advanced Energy can develop cost-effective turnkey power solutions that meet your exact needs.

### Modified Advantage

What you will get from Advanced Energy modified power supplies:

- Broad portfolio of power supplies to leverage from
- Quick time to market vs. custom solutions
- Low risk – using proven reliable platforms as building blocks
- Cost effective (lower development cost)
- Quality, high reliability products

## Modified Solutions

Advanced Energy provides modified standard products and value-add solutions in varying degrees of complexity. These meet specific customer needs in a wide range of applications, such as:



### Communications

- Access solutions
- Enterprise networking
- Wireless
- Wireline
- Optical



### Healthcare

- Bio life sciences
- Dental
- Imaging
- Laboratory
- Medical



### Industrial

- Process control
- Robotics
- Test & measurement



### Lighting & Signage

- Displays
- Illuminated signs



### Mil/Aero (COTS)

- Avionics
- In-flight entertainment



## Capabilities

The exact specifications you require that's within your budget reliability standards.

---



### Electrical Parameters

- Factory out preset
- Low noise
- Power & efficiency upgrades
- Hot swap control
- Inrush current control
- Integrated PDU assemblies
- Compliance to industry standards



### Packaging

- Conformal coating
- Custom chassis/sled
- Ruggedization for shock, vibration and hazardous locations
- Shielding for high magnetic environment
- Sealed/IP rated enclosures
- Customized print/marketing/labels



### Connectivity

- Cable wire assemblies
- Connector changes
- Busbar design
- Overmoulding
- Interposer boards



### Communications & Control

- Logic signal/timing changes
- Adaptive fan control
- Output sequencing
- Peak load/efficiency optimization



For international contact information,  
visit [advancedenergy.com](http://advancedenergy.com).

[powersales@aei.com](mailto:powersales@aei.com)  
+1 888 412 7832

## ABOUT ADVANCED ENERGY

Advanced Energy (AE) has devoted more than three decades to perfecting power for its global customers. We design and manufacture highly engineered, precision power conversion, measurement and control solutions for mission-critical applications and processes.

Our products enable customer innovation in complex applications for a wide range of industries including semiconductor equipment, industrial, manufacturing, telecommunications, data center computing, and medical. With deep applications know-how and responsive service and support across the globe, we build collaborative partnerships to meet rapid technological developments, propel growth for our customers, and innovate the future of power.

PRECISION | POWER | PERFORMANCE

---

Specifications are subject to change without notice. Not responsible for errors or omissions. ©2021 Advanced Energy Industries, Inc. All rights reserved. Advanced Energy®, AE®, CoolX®, and HV Rack® are U.S. trademarks of Advanced Energy Industries, Inc. PMBus™ is a trademark of SMIF, Inc.